



---

**Revised Clinical Study Protocol**

Study Code	PT003018 / FLUI-2015-139
NCT #	NCT02643082
Edition Number	Ver. 3 Amendment 2
Date	02 MAY 2016

---

---

**A Randomized, Double-Blind, Two Treatment, Two Period, Chronic Dosing (2 Weeks), Cross-Over, Single-Center Study to Evaluate the Effects of PT003 and Placebo MDI on Specific Image Based Airway Volumes and Resistance in Subjects With Moderate to Severe COPD**

---

This submission /document contains trade secrets and confidential commercial information, disclosure of which is prohibited without providing advance notice to AstraZeneca and opportunity to object.

**The following Amendment(s) are included in this revised protocol:**

<b>Amendment No.</b>	<b>Date of Amendment</b>	<b>Local Amendment No.</b>	<b>Date of local Amendment</b>
Version 1	15SEP2015		
Version 2, Amendment 1	16FEB2016		
Version 3, Amendment 2	02MAY2016		

## Clinical Trial Protocol: PT003018-02 / FLUI-2015-139

**Title:** A Randomized, Double-Blind, Two Treatment, Two Period, Chronic Dosing (2 Weeks), Cross-Over, Single-Center Study to Evaluate the Effects of PT003 and Placebo MDI on Specific Image Based Airway Volumes and Resistance in Subjects With Moderate to Severe COPD.

**Study Number:** PT003018-02 / FLUI-2015-139

**Study Phase:** IIIb

**Product Name:** Glycopyrronium and Formoterol Fumarate Inhalation Aerosol; PT003; Glycopyrronium and Formoterol Fumarate (GFF) Metered Dose Inhaler (MDI)  
Placebo Metered Dose Inhaler (MDI) for Glycopyrronium and Formoterol Fumarate Inhalation Aerosol

**EudraCT Number:** 2015-001743-36

**Indication:** COPD

**Investigators:** Single center

**Sponsor:** Pearl Therapeutics, Inc.

**Sponsor Contact:** [REDACTED]

	Version Number	Date
<b>Original Protocol:</b>	Version 1.0	[REDACTED]
<b>Amended Protocol #1</b>	Version 2.0	[REDACTED]
<b>Amended Protocol #2</b>	Version 3.0	[REDACTED]

### Confidentiality Statement

Property of Pearl Therapeutics, Inc.

This document is confidential and may not be used, divulged, published or otherwise disclosed without consent of Pearl Therapeutics, Inc.

## SUMMARY OF CHANGES TO PROTOCOL VERSION 2.0, DATED [REDACTED] FOR VERSION 3.0

The amended study protocol, PT003018-02/FLUI-2015-139 (Version 3.0), includes the following edits. Newly added text is shown in **bold font** and deleted text is shown as ~~strikethrough font~~.

No.	Description of Change	Rationale
1	<p><a href="#">Section 4.1 Overall Study Design and Plan</a></p> <p>Providing the subject meets the eligibility criteria, the Investigator or designee will review current COPD medications and, if necessary, will make arrangements to adjust the prohibited COPD therapy to protocol-allowable COPD therapy. <b>At Visit 1 (Screening), eligible</b> subjects who are <del>not</del> using a prohibited <b>COPD</b> medication (refer to Table 5-1) and meet all other entry criteria will return to the clinic <del>after 7 up and to 14</del> <b>21</b> days <del>after Screening</del> for Visit 2 (Randomization Visit). For more details on Visit 1 procedures, refer to <a href="#">Section 8.1</a></p>	<p>To provide clarification of wash-out of prohibited COPD medications prior to Visit 2 (Randomization)</p>
2	<p><a href="#">Section 4.1 Overall Study Design and Plan</a></p> <p><del>The baseline CT scans (TLC and FRC scan) will be taken at least 30 minutes prior to dosing. During the pre-dose assessments an additional</del> <b>assessments a</b> scan of the upper airway (UA) will be taken. After the CT-scans are taken, <b>spirometry and body plethysmography will be performed;</b> the inhalation profile will be measured with the body plethysmograph and respiration belts <del>and body plethysmography will be performed</del>. The subject's inhalation profile will be measured in order to draw an airflow versus time curve. At the moment of this measurement the signal from the respiration belt, used for the measurement of the inhalation profile during the study drug administration, will also be logged</p>	<p>To provide clarification that the CT scan will be obtained after the -60 minute FEV<sub>1</sub> and prior to the -30 minutes FEV<sub>1</sub> at Visit 2 (Randomization)</p>
3	<p><a href="#">Section 4.1 Overall Study Design and Plan</a></p>	<p>To provide clarification on which FEV<sub>1</sub> values at Visit 4 will be</p>

	<p>At Visit 4 (Day 1 of TP 2) it is important to ensure that the baseline FEV<sub>1</sub> is stable and reflective of the subject's COPD severity prior to continuing to the second treatment period. As such the baseline stability criteria will be evaluated (see section 5.1). <b>To ensure baseline FEV<sub>1</sub> stability at Visit 4 the -60 minute FEV<sub>1</sub> value obtained at Visit 4 will be compared to the average predose (-60 and -30 minute) FEV<sub>1</sub> values obtained at Visit 2.</b> Subjects meeting baseline stability criteria will be dispensed treatment period 2 study drug according to their assigned treatment sequence and will administer their first dose in the clinic under site personnel supervision. Subjects will undergo all protocol-defined assessments (see Table 8- and Table 8-10), will be discharged from the clinic, and will be instructed to continue study drug administration for approximately 2 weeks (14 days ± 5 days) until Visit 5. For more details on Visit 4 procedures, refer to Section 98.4 and Table 8-9</p>	<p>used to assess stability criteria</p>
<p>4</p>	<p><a href="#">Section 4.1.1 General Considerations for Treatment Visit 2 through Visit 5 (in-clinic)</a></p> <ul style="list-style-type: none"> <li>At the start of each treatment period (Visit 2 and Visit 4), prior to any study procedures being performed, site personnel must confirm the subject withheld all <del>non-study</del> <b>inhaled COPD medications, (including ICS and rescue medication, eg, Ventolin HFA),</b> except sponsor-provided Atrovent<sup>®</sup> HFA for at least 6 hours, by confirming the last time of dosing for all COPD medication(s)</li> </ul>	<p>Revised to provide clarification on the required washout of the inhaled COPD medications at the start of each Treatment Period</p>
<p>5</p>	<p><a href="#">Section 4.1.1 General Considerations for Treatment Visit 2 through Visit 5 (in-clinic)</a></p> <p><b>Note:</b> Subjects who inadvertently took <b>inhaled COPD medication(s)</b> (<del>except for sponsor-provided Atrovent<sup>®</sup> HFA</del>) within 6 hours of the start of study procedures must be rescheduled as soon as is practical but within the specified visit</p>	<p>“(except for sponsor-provided Atrovent<sup>®</sup> HFA)” deleted to provide clarification on the required washout of prohibited inhaled COPD medications at the end of each Treatment Period</p>



	window	
6	<p><a href="#">Section 5.1 Inclusion Criteria</a></p> <p>8. Stability criteria:</p> <p>At Visit 4 if the pre-dose <b>-60 minute</b> FEV<sub>1</sub> value is outside of the <math>\pm 20\%</math> range compared to the <b>average (-30 and -60 minute)</b> pre-dose FEV<sub>1</sub> value of Visit 2, the visit may be rescheduled at the Investigator's discretion, or the subject may be discontinued</p>	<p>Edited to provide clarification on which FEV<sub>1</sub> values at Visit 4 will be used to assess stability criteria</p>
7	<p><a href="#">Section 5.4.1 Prohibited COPD Medications</a></p> <p>The following medications used for the treatment of COPD are not permitted during this study. These medications must be discontinued at <b>6 hours to 24 hours prior to</b> Visit 1 (Screening) and are not permitted during the run-in period. The minimum washout period <b>before Visit 1 and</b> between Visit 1 and Visit 2 <b>is are</b> shown in <a href="#">Table 5-1</a>. <b>The only COPD medications permitted during the study are sponsor-provided Atrovent HFA<sup>®</sup> for COPD maintainance during the run-in and wash-out period and sponsor-provided Ventolin HFA<sup>®</sup> for rescue of COPD symptoms during the study</b></p>	<p>Addition of prohibited COPD medication washout requirements prior to Visit 1 (Screening)</p>
8	<p><a href="#">Table 5-1 Prohibited COPD Medications and Required Washout Periods Prior to Visit 2</a></p> <p>Prohibited COPD Medications and Required Washout Periods Prior to <b>Visit 1 and</b> Visit 2</p>	<p>Table title edited to include Visit 1 and prohibited COPD medications requiring washout prior to Visit 1 (Screening) added</p>
9	<p><a href="#">Table 5-1 Prohibited COPD Medications and Required Washout Periods Prior to Visit 2</a></p>	<p>Edited to provide clarification of the prohibited COPD medications and the wash-out requirements of prohibited COPD medications prior to Visit 1 (Screening)</p>

		Minimum Washout Period Prior to:	
Class of Medication		Visit 1	Visit 2
LAMAs		24 hours	Tiotropium: 14 days Acclidinium: 7 days Glycopyrronium: 7 days Umeclidinium: 7 days
Short-acting muscarinic antagonists (SAMA) <sup>a</sup>		6 hours	6 hours
LABAs (inhaled)		24 hours	48 hours (Indacaterol: 15 days)
Fixed-combinations of LABA/LAMA		24 hours	7 days (15 days for indacaterol/glycopyrronium and olodaterol/tiotropium)
Fixed-combinations of LABA/ICS		24 hours	7 days
Fixed-combinations of SABAs and SAMAs		6 hours	6 hours
SABAs <sup>b</sup>		6 hours	6 hours
Oral $\beta$ -agonists			2 days
Theophylline (total daily dose >400 mg/day) <sup>c</sup>			7 days
Monotherapy of ICS			6 hours

10	<p><a href="#">Section 5.4.1 Prohibited COPD Medications</a></p> <ul style="list-style-type: none"> <li>Subjects taking <b>prohibited</b> COPD medications (listed previously) at Visit 1 (Screening) will discontinue these medications <b>6 to 24 hours before Visit 1</b> for the duration of the trial. <b>At Visit 1 subjects will</b> and be switched to sponsor-provided Atrovent HFA MDI administered QID and sponsor-provided Ventolin HFA to be administered up to four times per day as needed (PRN) for control of symptoms during the run-in period</li> </ul>	Revised to provide clarification of the washout requirements of prohibited COPD medications prior to Visit 1 (Screening)
11	<p><a href="#">Section 5.4.1 Prohibited COPD Medications</a></p> <ul style="list-style-type: none"> <li><b>At Visit 1, subjects who meet all entry criteria and are taking prohibited COPD medications in Table 5-1 will start with sponsor-provided Atrovent HFA MDI administered QID for COPD maintenance, and sponsor-provided Ventolin HFA to be administered up to four times per day, as needed (PRN) for control of symptoms during the run-in period</b></li> </ul>	Bullet 7 added to provide clarification that subjects who meet all entry criteria and are using one or more of the prohibited COPD medications will start with sponsor-provided Atrovent HFA and sponsor-provided Ventolin HFA at Visit 1 (Screening)
12	<p><a href="#">Section 5.7 Reasons and Procedures for Early Termination</a></p>	Revised to provide clarification of the definition of baseline

	<ul style="list-style-type: none"> <li>Following dosing, a heart rate increase of greater than 40 bpm from the pre-dose value obtained on Day 1 of <del>each</del> Treatment Period <del>2</del> <b>1</b> (Visit 2) and Treatment Period <del>3</del> <b>2</b> (Visit 4) <del>Period</del> and the measured value is also &gt;120 bpm</li> </ul>	
13	<p><a href="#">Section 5.7 Reasons and Procedures for Early Termination</a></p> <ul style="list-style-type: none"> <li>Following dosing, a systolic blood pressure (SBP) increase of more than 40 mmHg from the pre-dose value obtained on Day 1 of <del>each</del> Treatment Period <del>2</del> <b>1</b> (Visit 2) and Treatment Period <del>3</del> <b>2</b> (Visit 4) and the measured value is also &gt;160 mmHg</li> </ul>	Revised to provide clarification of the definition of baseline
14	<p><a href="#">Section 5.7 Reasons and Procedures for Early Termination</a></p> <ul style="list-style-type: none"> <li><b>Initiation of corticosteroids/antibiotics for the treatment of exacerbation</b></li> </ul>	Bullet 12 added to provide clarification that the initiation of corticosteroids/antibiotics for the treatment of an exacerbation will be a reason for early termination
15	<p><a href="#">Section 7.1.2 Spirometry</a></p> <p>At Visit 2 and Visit 4, spirometry will be obtained at the beginning of the visit. A second spirometry will be obtained before the study drug administration after the pre-dose CT-scans are taken. The <del>average of the -60 minute</del> <b>value</b> obtained at Visit 4 prior to study drug administration will be used to check the stability criteria. At Visit 3 and Visit 5, spirometry will be obtained before the study drug administration, and post-dosing of study drug. Post-dose spirometry assessments will not be conducted before the CT-scan is taken. At Visits 3 and 5 none of the post dose assessments will start before 1 hour after the administration of the study drug. All assessments should be completed within 2.5 hours after dosing</p>	Revised to provide clarification on which FEV <sub>1</sub> values at Visit 4 will be used to assess the stability criteria
16	<p><a href="#">Section 7.1.2.2 Stability Criteria</a></p> <p>At Visit 2, spirometry will be obtained at the</p>	Revised to provide clarification on which FEV <sub>1</sub> values at Visit 4 will be used to assess the stability criteria

	<p>beginning of the visit. A second spirometry will be obtained before the study drug administration after the pre-dose CT scans are taken. The average of the FEV<sub>1</sub> values obtained prior to study drug administration (- 60 min and - 30 min) <b>at Visit 2</b> will be the baseline value used to compare with the <del>average of -60 minute</del> FEV<sub>1</sub> value obtained at Visit 4</p>	
17	<p><a href="#">Table 8-9 Schedule of events</a></p> <p>Addition of study drug dispensing/collection and review/record Ventolin HFA dose indicator reading at Visit 1 and review of Diary at Visit 4</p>	<p>Revised to provide clarification that study drug dispensing collection and review/record Ventolin HFA dose indicator reading at Visit 1 and Diary will be reviewed at Visit 4</p>
18	<p><a href="#">Table 8-9 Schedule of events</a></p> <p><sup>a</sup> Scheduling visits: The maximum run-in period is 21 days. The earliest a subject can be randomized from the Visit 1 date is 7 days (7 days for LABA washout <del>) or 21 days for flexibility</del>) or 21 days for flexibility.). The site should make every effort to maintain subjects within the scheduled visit window</p>	<p>Removal of “) or 21 days for flexibility” for clarification purposes</p>
19	<p><a href="#">Table 8-9 Schedule of events</a></p> <p><sup>i</sup> After obtaining informed consent <del>or at Visit 1 (Screening), stop prohibited COPD medications and change COPD medications</del> <b>subjects will be instructed to withhold prohibited COPD medications 6 hours to 24 hours before Visit 1 (Screening). At Visit 1 (Screening), subjects will be given Sponsor-provided Atrovent HFA with or without ICS, rescue Ventolin HFA only after a subject is determined to be eligible to proceed to Visit 2 (Day 1) (i.e., only if a subject meets the definition of COPD following spirometry assessments at Screening)</b></p>	<p>Revised to provide clarification on wash-out instruction after obtaining informed consent and when subjects will be provided Sponsor-provided Atrovent HFA with or without ICS, rescue Ventolin HFA</p>
20	<p><a href="#">Table 8-9 Schedule of events</a></p> <p><sup>j</sup> <b>At Visit 1 COPD medications will be changed</b> as specified in the protocol (i.e., Sponsor provided Atrovent HFA with or without</p>	<p>Revised to provide clarification on the washout requirements of prohibited COPD medications prior to Visit 1 (Screening)</p>

	ICS). At the end of Visit 5, return subject to pre-study or other appropriate inhaled maintenance COPD medications	
21	<p><a href="#">Table 8-9 Schedule of events</a></p> <p><sup>k</sup> <del>Sponsor provided Atrovent HFA or Ventolin HFA is dispensed only after a subject is determined to be eligible to proceed to Visit 2 (Day 1) (i.e., only if a subject meets the definition of COPD following spirometry assessments at Screening)</del></p>	Deleted as previously stated in footnote “i”
22	<p><a href="#">Table 8-9 Schedule of events</a></p> <p><b>Note:</b> Site should plan to perform these activities so as not to interfere with collection of timed assessments such as spirometry. Where data collection time-points are concurrent, variables must be collected in the following order: On Day 1 of each treatment period: <i>Pre-dose:</i> Urine pregnancy test, Spirometry (obtain FEV<sub>1</sub> to <del>evaluate</del> <b>evaluate</b> stability criteria), vital signs, ECG, clinical laboratory assessments. <del>(in case a retest is needed during eGFR at</del> <b>eGFR at Visit 2 1 (screening) must be repeated prior to Visit 2 and have the results available at Visit 2 to confirm</b> eligibility <del>this can be performed earlier)</del>, Pre-dose CT scans, Spirometry, Body Plethysmography, Inhalation Profile. <i>Post-dose:</i> vital signs, ECG. On Day 15 (± 5 days) of each TP: <i>Pre-dose:</i> Urine pregnancy test, vital signs, ECG, clinical laboratory assessments <i>Post-dose:</i> Vital signs, ECG, post-dose CT Scan, Spirometry, Body Plethysmography</p>	Revised to provide clarification that subjects not meeting eGFR criterion at visit 1 must meet the criterion on repeat testing prior to Visit 2 to confirm eligibility
23	<p><a href="#">Table 8-10. Timed Assessments at Visit 2 and Visit 4</a></p> <p><del><sup>e</sup> At the start of each treatment visit, subject must withhold all COPD medications, including study medication, rescue Ventolin HFA and ICS for at least 6 hours prior to start of test day procedures (except for sponsor provided Atrovent® HFA at Visit 2 and Visit 4).<sup>d</sup> This is not a timed assessment. Sites should plan to</del></p>	Revised to provide clarification on which activities are not timed assessments

	<p><del>perform these activities so as not to interfere with collection of timed assessments such as spirometry.</del></p> <p><del><b>Note:</b> Subjects with a calculated creatinine clearance <math>&lt; 30 \text{ ml/min/1.73 m}^2</math> MDRD at Visit 1 must have a <math>e\text{GFR}_{\text{MDRD}} &gt; 30 \text{ ml/min/1.73 m}^2</math> on the repeat testing prior to Visit 2 to be randomized in this study</del></p>	
24	<p>Table 8-10. Timed Assessments at Visit 2 and Visit 4</p> <p><sup>i</sup> Will be performed at the beginning of the visit. <del>The</del> <b>At Visit 4 the obtained -60 minute</b> FEV<sub>1</sub> value will be used to check the stability criteria</p>	Revised to provide clarification on which FEV <sub>1</sub> values at Visit 4 will be used to assess the stability criteria
25	<p>Table 8-11. Timed Assessments at Visit 3 and Visit 5</p> <p>Footnotes “b” and “c” realigned</p>	Revised to provide clarification on which activities are not timed activities at Visit 3 and Visit 4
26	<p>Table 8-11. Timed Assessments at Visit 3 and Visit 5</p> <p><b>Note:</b> Site should plan to perform these activities so as not to interfere with collection of timed assessments such as spirometry. Where data collection time-points are concurrent, variables must be collected in the following order: Predose: Urine pregnancy test, <b>spirometry</b>, vital signs, ECG, clinical laboratory assessments Postdose: Vital signs, ECG post-dose CT scan, spirometry, body plethysmography</p>	Addition of spirometry assessment to the predose assessments conducted at Visit 5
27	<p>Section 8.1 Visit 1 (Screening)</p> <ul style="list-style-type: none"> <li>Obtain informed consent <b>prior to or at the beginning of Visit 1 prior to conducting any study related procedures</b></li> </ul>	Revised to provide clarification that informed consent can be obtained prior to or at the beginning of Visit 1 prior to conducting any study related procedures
28	<p>Section 8.1 Visit 1 (Screening)</p> <ul style="list-style-type: none"> <li><b>Determine time of last dose of prohibited COPD medication as defined in table 5-1</b></li> </ul>	Revised to provide clarification that the time of last dose of prohibited COPD medication as defined in Table 5-1 must be determined
29	<p>Section 8.1 Visit 1 (Screening)</p>	Revised to o provide clarification on when subjects will be

	<ul style="list-style-type: none"> <li>• <del>Stop prohibited COPD medications and change</del> <b>Change</b> concurrent COPD medications as specified in protocol (refer to <a href="#">Section 5.4.1</a>). Sponsor will provide Atrovent HFA QID for COPD maintenance and Ventolin HFA as needed for symptomatic relief</li> </ul>	instructed subjects to begin wash-out of their concurrent COPD medications as per Table 5-1
30	<p><a href="#">Section 8.2 Visit 2 (Randomization) Day 1 of TP 1</a></p> <p><b>Note:</b> Review inclusion/exclusion criteria, repeat testing of the creatinine clearance <b>prior to Visit 2, if necessary. Creatinine clearance eligibility</b> must be known before the HRCT scan can be taken</p>	Revised to provide clarification that the results of repeat testing of the creatinine clearance, which has to be performed prior to Visit 2, must be known before the HRCT scan can be taken
31	<p><a href="#">Section 8.4 Visit 4 (Day 1 of TP 2)</a></p> <p><b>Note: Confirm if patient meets stability requirements, if not the visit may be rescheduled within the allowed visit window, at the Investigator’s discretion, or the subject may be discontinued</b></p>	Note was added to clarify if a subject does not meet stability criteria at Visit 4 the visit may be rescheduled or the subject may be discontinued
32	<p><a href="#">Section 8.4 Visit 4 (Day 1 of TP 2)</a></p> <ul style="list-style-type: none"> <li>• Subjects will be instructed to bring all study medication (including used study drug, replacement MDI kit, <del>sponsor provided Atrovent HFA,</del> and rescue Ventolin HFA) and the Diary to the next scheduled clinic visit</li> </ul>	Revised to provide clarification that subjects will be instructed at Visit 4 to bring study drug, replacement MDI kit, and rescue Ventolin HFA to their next scheduled visit
33	Minor typographical errors were addressed but not captured as individual items in the summary of changes	To improve readability



## SYNOPSIS

<b>Sponsor:</b> Pearl Therapeutics Inc. (“Pearl”) [REDACTED]
<b>Names of Finished Products:</b> Glycopyrronium and Formoterol Fumarate Inhalation Aerosol; PT003, Glycopyrronium and Formoterol Fumarate Metered Dose Inhaler (GFF MDI)  Placebo Metered Dose Inhaler (MDI) for Glycopyrronium and Formoterol Fumarate Inhalation Aerosol
<b>Name of Active Ingredients:</b> Glycopyrronium and Formoterol Fumarate
<b>Study Title:</b> A Randomized, Double-Blind, Two Treatment, Two Period, Chronic Dosing (2 Weeks), Cross-Over, Single-Center Study to Evaluate the Effects of PT003 and Placebo MDI on Specific Image Based Airway Volumes and Resistance in Subjects With Moderate to Severe COPD.
<b>Study Number:</b> PT003018-02 / FLUI-2015-139
<b>Study Phase:</b> IIIb
<b>Study Objectives:</b> <b>Primary Objectives:</b> <ul style="list-style-type: none"><li>• To assess the effect of treatment with GFF MDI, twice daily (BID) compared with Placebo MDI on specific image-based airway volumes and resistance in subjects with moderate to severe chronic obstructive pulmonary disease (COPD) following chronic dosing after approximately two weeks treatment.</li></ul> <b>Secondary Objectives:</b> <ul style="list-style-type: none"><li>• To compare the effects of GFF MDI on various Functional Respiratory Imaging (FRI) parameters.</li><li>• To compare the effects of GFF MDI and Placebo MDI on pulmonary function test (PFT) parameters.</li></ul>
<b>Safety Objective:</b> To assess the safety of GFF MDI in subjects with moderate to severe COPD based on adverse events (AEs), and any clinically relevant findings from vital sign measurements, electrocardiograms (ECGs), physical examination findings and clinical laboratory evaluations.
<b>Study Design:</b> This is a single center, double-blind, two treatment, two period, full cross-over, chronic dosing (2 weeks) study to assess the effects of GFF MDI (14.4/9.6 µg BID) compared with Placebo MDI on specific image-based airway volumes and resistance in subjects with moderate to severe COPD. The sensitivity of the study increases with the crossover design where each subject acts as



his/her own control. In this study the calculation of airway dimension parameters between the active compound and the placebo will be compared within the same subject after the administration of both the active compound as well as the placebo.

It is planned to conduct this single-center study at one site in Belgium, with the site contributing approximately 20 randomized subjects with moderate to severe COPD.

**Study design chart**

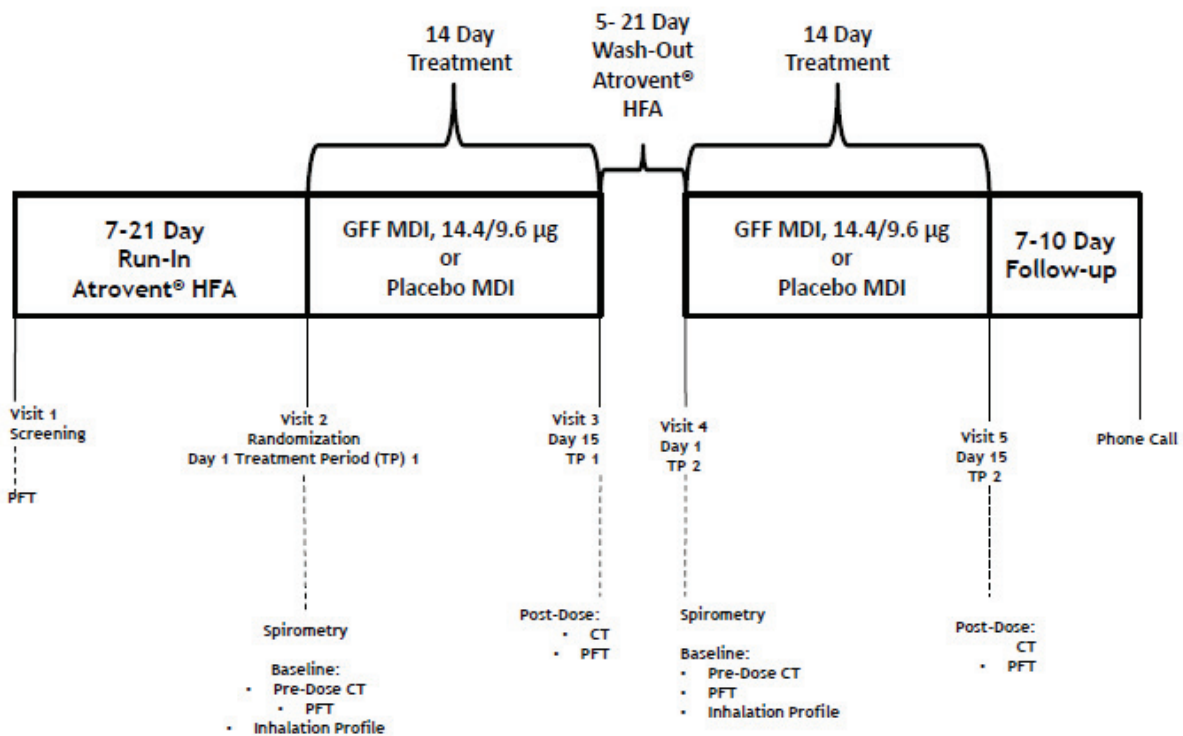

**Computed Tomography (CT)-scans during study:** On Day 1 of each Treatment Period (TP [Visit 2 and Visit 4]) baseline measurement inspiratory scan (total lung capacity [TLC] scan) and expiratory scan (functional residual capacity [FRC] scan) will be conducted. During Visit 2 an additional scan of the upper airway (UA) will be taken. Post dose measurement inspiratory scan (total lung capacity [TLC] scan) will be taken after approximately 2 weeks of treatment with either GFF MDI or Placebo MDI on Day 15 (± 5 days) (Visit 3 and Visit 5). Post dose activities should be started 1 hour after dosing on Visit 3 and Visit 5 and should be concluded within 2.5 hours after dosing. Between the Treatment Periods there will be a washout period of 5-21 days.

**Study Duration:**

The entire study period is scheduled to take approximately 13 weeks for each individual subject.

**Study Population:**

Approximately 20 subjects with moderate to severe COPD will be randomized into the study

**Test Product, Dose, and Mode of Administration:**

Investigational materials will be provided by Pearl as summarized.

**Investigational materials**

Product Name and Dosage	Product Strength	Dose Form/Fill Count	Administration
<b>Study Medications</b>			
GFF MDI (PT003) 14.4/9.6 µg ex-actuator	GFF MDI 7.2/4.8 µg per actuation	1 MDI 120 inhalations	Taken as two inhalations BID
<b>Open-label Products</b>			
Ventolin (albuterol sulfate) HFA inhalation aerosol 90 µg ex-actuator	Ventolin (albuterol sulfate) HFA inhalation aerosol will be the supplied product Each inhalation contains 108 µg corresponding to 90 µg albuterol base per actuation	1 MDI 60 or 200 actuations	Taken as needed (PRN)
Atrovent (ipratropium bromide) HFA inhalation aerosol 34 µg ex-actuator	Atrovent (ipratropium bromide) HFA will be the supplied product Each inhalation contains 17 µg ex-actuator per actuation	1 MDI 200 actuations	Taken as two inhalations QID during run-in period and washout period
<b>Placebo</b>			
Placebo MDI	Formulation does not contain active ingredient	1 MDI 120 inhalations	Taken as two inhalations BID

Abbreviations: BID=twice daily; COPD=chronic obstructive pulmonary disease; GFF MDI=Glycopyrronium and Formoterol Fumarate Inhalation Aerosol; MDI=Metered Dose Inhaler; PRN=as needed; QID=four times daily

**Note:** All study drugs will be administered by oral inhalation.

**Note:** Glycopyrronium 14.4 µg in GFF MDI is equivalent to 18 µg of glycopyrronium bromide.

**Duration of Treatment:**

Each subject will receive in total study treatment for approximately 4 weeks (two separate TPs of approximately two weeks). The entire study is scheduled to take approximately 13 weeks for each individual subject from the time of screening through follow-up.

**Primary Efficacy Endpoints:**

**FRI Parameters:**

- Specific airway volume (siVaw)

- Specific airway resistance (siRaw)

**Secondary Efficacy Endpoints:**

**FRI Parameters:**

- Airway volume (iVaw)
- Airway resistance (iRaw)

**Spirometry Parameters:**

- Forced expiratory volume in one second (FEV<sub>1</sub>)

**Body Plethysmography Parameters:**

- FRC

**Other Efficacy Endpoints:**

**FRI Parameters:**

- Lobe volumes (iVlobes)
- Air trapping
- Internal lobar airflow distribution
- Low attenuation or emphysema score
- Blood vessel density or fibrosis score
- Airway wall thickness
- Mass of deposited particles per defined airway section

**Spirometry Parameters:**

- Forced vital capacity (FVC)
- Tiffeneau index (FEV<sub>1</sub>/FVC ratio)
- Forced expiratory flow 25%-75% (FEF<sub>25-75</sub>)
- Inspiratory capacity (IC)

**Body Plethysmography Parameters:**

- Residual volume (RV)
- TLC
- Airway resistance (Raw)
- Specific airway resistance (sRaw)
- Specific airway conductance (sGaw)

**Safety Endpoints:**

- AEs

**Statistical Methods:**

All statistical analysis will be conducted using [REDACTED].

For the efficacy analyses, the null hypothesis for each pair-wise comparison will be that the mean GFF MDI treatment effect is equal to that of Placebo MDI; the alternative hypothesis is then that the GFF MDI treatment effect and that of Placebo MDI (or an individual component) are not equal. P-values will thus be reported as two-sided. The effect is defined as the difference between the value at Day 15 ( $\pm 5$  days) and the value at Day 1 of a certain TP. Effect is thus defined as the change from baseline to placebo, for a placebo treatment and as the change from baseline to GFF MDI, for a GFF MDI treatment. The null ( $H_0$ ) and alternative ( $H_1$ ) hypotheses with  $\mu$  representing the mean are:

$$H_0: \mu_{\text{GFF}} = \mu_{\text{placebo}}$$

$$H_1: \mu_{\text{GFF}} \neq \mu_{\text{placebo}}$$

For each parameter in each group (primary efficacy endpoints: FRI; secondary efficacy endpoints: FRI, spirometry and body plethysmography; other efficacy endpoints: all FRI parameters except the mass of deposited particles, spirometry and body plethysmography), this null hypothesis will be tested. A linear mixed model approach will be chosen and specified fully in the statistical analysis plan.

For the primary efficacy endpoints, Hochberg's step-up procedure will be used as multiplicity adjustment. No correction will be performed for the secondary and the other efficacy endpoints.

In order to gain extra insight into the mode of action of the product, additional exploratory analyses can be executed using (robust) linear regression or mixed-models.

The Intent-to-Treat (ITT) Population will be considered the primary analysis population for efficacy.

**Date of Approved Protocol:** [REDACTED]

<b>Date of Protocol Amendment 1 (Version 2.0):</b> [REDACTED]
<b>Date of Protocol Amendment 2 (Version 3.0):</b> [REDACTED]

## TABLE OF CONTENTS

SUMMARY OF CHANGES TO PROTOCOL VERSION 2.0, [REDACTED] FOR VERSION 3.0 .....	2
SYNOPSIS.....	11
TABLE OF CONTENTS.....	17
LIST OF IN-TEXT TABLES .....	21
LIST OF IN-TEXT FIGURES.....	21
LIST OF APPENDICES.....	21
LIST OF ABBREVIATIONS AND DEFINITIONS OF TERMS.....	22
TRADEMARK INFORMATION .....	26
1 INTRODUCTION AND STUDY RATIONALE .....	27
1.1 Study Rationale.....	29
2 STUDY OBJECTIVES.....	30
2.1 Primary Objective .....	30
2.2 Secondary Objectives.....	30
2.3 Safety Objectives .....	30
3 STUDY ENDPOINTS .....	31
3.1 Efficacy Endpoints.....	31
3.1.1 Primary Efficacy Endpoints.....	31
3.1.2 Secondary Efficacy Endpoints.....	31
3.1.3 Other Efficacy Endpoints.....	32
3.2 Safety Endpoints .....	32
4 INVESTIGATIONAL PLAN.....	33
4.1 Overall Study Design and Plan .....	33
4.1.1 General Considerations for Treatment Visit 2 through Visit 5 (in-clinic):..	35
4.2 Rationale of Study Design .....	40
4.3 Rationale of Dose/Regimen, Duration of Treatment, and Placebo Arm .....	40
5 STUDY POPULATION SELECTION AND WITHDRAWAL CRITERIA .....	41
5.1 Inclusion Criteria.....	41
5.2 Exclusion Criteria .....	42
5.3 Subject Identification .....	47
5.4 Prior, Concomitant, and Prohibited Medications.....	47
5.4.1 Prohibited COPD Medications .....	47
5.4.2 Other Prohibited Medications.....	50
5.5 Other Restrictions, Illicit Drugs or Drugs of Abuse .....	51
5.5.1 Illicit Drugs and/or Drugs of Abuse.....	51

5.5.2	Dietary Restrictions .....	51
5.6	Smoking Status .....	52
5.7	Reasons and Procedures for Early Termination.....	52
6	LABELING, PACKAGING, STORAGE, DISPENSING, AND RETURN OF CLINICAL SUPPLIES .....	54
6.1	Subject Information .....	54
6.2	Product Descriptions.....	54
6.3	Primary Packaging and Labeling Information .....	55
6.4	Secondary Packaging and Labeling Information (Box).....	56
6.5	Emergency Unblinding of Treatment Assignment .....	57
6.6	Storage Requirements .....	57
6.7	Instructions for Preparation of Treatments for Administration and Dispensing.....	58
6.7.1	GFF MDI and Placebo MDI .....	58
6.7.2	Atrovent HFA (Ipratropium Bromide).....	58
6.7.3	Ventolin HFA (Albuterol Sulfate) .....	59
6.8	Drug Accountability/Return of Clinical Supplies.....	59
7	STUDY PROCEDURES .....	60
7.1	Efficacy Assessments.....	60
7.1.1	HRCT scans .....	60
7.1.2	Spirometry.....	61
7.1.2.1	Characterization of Reversibility .....	61
7.1.2.2	Stability Criteria.....	62
7.1.2.3	Inspiratory Capacity.....	62
7.1.2.4	Standardization of IC and Spirometry Collections .....	62
7.1.3	Body plethysmography .....	62
7.1.4	Diffusion capacity.....	63
7.1.5	Inhalation Profile with Body Plethysmography.....	63
7.1.6	Inhalation Profile during administration.....	63
7.1.7	Subject Diary Data Collection .....	63
7.1.8	Rescue Ventolin HFA Use.....	64
7.1.9	Recording of Dose Indicator Reading.....	64
7.1.10	Subject Questionnaires.....	65
7.1.10.1	COPD Assessment Test .....	65
7.1.10.2	Modified Medical Research Council Dyspnea Scale .....	65
7.1.11	COPD Exacerbations .....	66
7.2	Safety Assessments.....	67
7.2.1	Medical/Surgical History and Physical Examination .....	67
7.2.2	Vital Sign Measurements.....	67
7.2.3	12-Lead Electrocardiogram .....	68

7.2.4	Clinical Laboratory Tests.....	69
7.2.4.1	Hematology.....	69
7.2.4.2	Clinical Chemistry.....	69
7.2.4.3	Urinalysis.....	70
7.2.4.4	Pregnancy Test.....	71
7.3	Adverse Events.....	71
7.3.1	Performing Adverse Events Assessments.....	71
7.3.2	Adverse Event Definitions.....	71
7.3.3	Pre-Randomization Adverse Events.....	72
7.3.4	Severity.....	72
7.3.5	Relationship.....	72
7.3.6	Clinical Laboratory Adverse Events.....	73
7.3.7	Serious Adverse Events.....	73
7.3.7.1	Reporting Serious Adverse Events.....	74
7.3.7.2	Supplemental Investigations of SAEs.....	75
7.3.7.3	Post-Study Follow-Up of Adverse Events.....	75
7.3.7.4	Notification of Post-Study Serious Adverse Events.....	75
7.3.7.5	IRB/IEC Notification of Serious Adverse Events.....	75
7.3.7.6	Health Authority Safety Reports.....	75
7.3.8	Overdose.....	75
7.3.9	Pregnancy.....	76
7.4	Termination of the Study.....	76
8	STUDY ACTIVITIES.....	77
8.1	Visit 1 (Screening).....	85
8.2	Visit 2 (Randomization: Day 1 of TP 1).....	86
8.3	Visit 3 (Day 15 ± 5 days of TP 1).....	88
8.4	Visit 4 (Day 1 of TP 2).....	89
8.5	Visit 5 (Day 15 ± 5 days of TP 2).....	91
8.6	Unscheduled Visit/Premature Discontinuation Visit.....	92
8.7	Follow-Up Telephone Call.....	92
8.8	Completion of the Study.....	92
9	PLANNED STATISTICAL METHODS.....	94
9.1	Introduction.....	94
9.2	Protocol Variables.....	94
9.2.1	Efficacy Endpoints.....	94
9.2.1.1	Primary Efficacy Endpoints on Day 1 and Day 15, except as otherwise noted.....	94
9.2.1.2	Secondary Efficacy Endpoints measured on Day 1 and Day 15, except as otherwise noted.....	94
9.2.1.3	Other Efficacy Endpoints measured on Day 1 and Day 15, except as otherwise noted.....	95



9.2.1.4	Safety Endpoints .....	96
9.3	Efficacy Analyses .....	96
9.3.1	Efficacy Analysis .....	96
9.3.2	Control of Type I error.....	96
9.3.3	Safety Analysis .....	96
9.3.3.1	Adverse Events .....	96
9.4	Randomization .....	97
9.5	Experimental design.....	97
9.6	Sample Size Consideration .....	97
9.7	Data Validation and Transformation .....	97
9.8	Analysis Plan .....	98
9.9	Study Populations .....	98
9.10	Handling of Missing Data.....	98
9.11	Statistical Software .....	98
10	ADMINISTRATIVE CONSIDERATIONS.....	99
10.1	Regulatory Authority Approval .....	99
10.2	Ethical Conduct of the Study and Institutional Review Board (IRB) or Independent Ethics Committee (IEC) Approval.....	99
10.3	Subject Information and Consent.....	99
10.4	Laboratory Accreditation .....	100
10.5	Confidentiality .....	100
10.5.1	Confidentiality of Data .....	100
10.5.2	Confidentiality of Subject/Subject Records.....	100
10.6	Quality Control and Assurance.....	100
10.7	Data Management .....	100
10.8	Study Monitoring .....	101
10.9	Retention of Data .....	102
10.10	Financial Disclosure.....	102
10.11	Investigator's Final Report .....	102
10.12	Publication Policy .....	102
11	REFERENCE LIST .....	104
12	APPENDICES .....	106

## LIST OF IN-TEXT TABLES

Table 5-1	Prohibited COPD Medications and Required Washout Periods Prior to Visit 2: Title was revised .....	4
Table 5-1	Prohibited COPD Medications and Required Washout Periods Prior to Visit 1 and Visit 2 .....	48
Table 5-2:	Other Respiratory/Nasal Medications: Required Washout Periods .....	50
Table 5-3:	Non-COPD Medications Allowed Under Certain Condition .....	50
Table 5-4:	Prohibited Medications .....	51
Table 6-5.	Study Product Packaging Descriptions .....	55
Table 6-6.	Description of Boxes .....	56
Table 7-7:	MMRC Dyspnea Scale .....	66
Table 7-8:	Lab Parameters .....	70
Table 8-10:	Timed Assessments at Visit 2 and Visit 4 .....	81
Table 8-11:	Timed Assessments at Visit 3 and Visit 5 .....	83
Table 9-11:	Randomization Schedule .....	97

## LIST OF IN-TEXT FIGURES

Figure 1	Study Design Chart .....	39
Figure A1-1.	Indicator at Top of Canister .....	106
Figure A1-2.	Wash Actuator through Top of Actuator .....	107
Figure A1-3.	Wash Actuator through Mouthpiece .....	108
Figure A1-4.	Metered Dose Inhaler Parts .....	109

## LIST OF APPENDICES

Appendix 1	Subject Instructions for Use of GFF and Placebo MDI .....	106
Appendix 2	Instructions for Use of Atrovent HFA Inhalation Aerosol Device .....	110
Appendix 3	Instructions for Use of Ventolin HFA Inhaler .....	113
Appendix 4	COPD Assessment Test .....	121
Appendix 5	Modified Medical Research Council Dyspnea Scale Assessment .....	122
Appendix 6	Dose Indicator Display Reading Instructions .....	123
Appendix 7	Protocol of HRCT scan and CFD method .....	124
Appendix 8	Sponsor Signatory .....	126
Appendix 9	Investigator's Agreement and Signature Page .....	127

## LIST OF ABBREVIATIONS AND DEFINITIONS OF TERMS

AE	Adverse event
ALT	Alanine aminotransferase
AST	Aspartate aminotransferase
ATS	American Thoracic Society
AV	Atrioventricular block
BID	bis in die, Twice Daily
BiPAP	Bilevel Positive Airway Pressure
Bpm	Beats per minute
BUN	Blood urea nitrogen
CAT	COPD Assessment Test
CFD	Computational fluid dynamics
CFR	Code of Federal Regulations
CHF	Congestive Heart Failure
CHMP	Committee for Medicinal Products for Human Use
CONSORT	Consolidated Standards of Reporting Trials
COPD	Chronic Obstructive Pulmonary Disease
CPAP	Continuous Positive Airway Pressure
CT	Computed Tomography
DBP	Diastolic blood pressure
ECG	Electrocardiogram
eCRF	Electronic Case Report Form
Eg	Exempli gratia, for example
ER	Emergency Room
ERS	European Respiratory Society
EU	European Union
ex-actuator	Dose Delivered From The Actuator (ie, mouthpiece) Of The MDI
FDA	Food and Drug Administration
FEF <sub>25-75</sub>	Forced Expiratory Flow between 25% to 75% of FVC
FEV <sub>1</sub>	Forced Expiratory Volume In 1 Second
FF MDI	Formoterol Fumarate MDI

FRC	Functional Residual Capacity
FRI	Functional Respiratory Imaging
FVC	Forced Vital Capacity
GCP	Good Clinical Practice
GFF MDI	Glycopyrronium and Formoterol Fumarate MDI
$GFR_{MDRD}$	Glomerular Filtration Rate estimated using the Modification of Diet in Renal Disease equation
GOLD	Global Initiative for Chronic Obstructive Lung Disease
GP MDI	Glycopyrronium MDI
$H_0$	Null Hypothesis
$H_1$	Alternative Hypothesis
HCG	Human Chorionic Gonadotropin
HFA	Hydrofluoroalkane
HRCT	High Resolution Computed Tomography
IB	Investigator's Brochure
IC	Inspiratory Capacity
ICF	Informed Consent Form
ICH	International Conference on Harmonization
ICMJE	International Committee of Medical Journal Editors
ICS	Inhaled Corticosteroid
ID	Identification
ie	Id est, that is
IEC	Independent Ethics Committee
IPF	Interstitial Pulmonary Fibrosis
$iR_{aw}$	Image based Airway resistance
IRB	Institutional Review Board
ITT	Intention-to-treat
IUD	Intrauterine device
$iV_{aw}$	Image based Airway volume
$iV_{aww}$	Airway wall volume
$iV_{lobes}$	Image based Lobe volumes
L	Liter
LABA	Long-acting Beta Agonist

LAMA	Long-acting Muscarinic Antagonist
LTOT	Long Term Oxygen Therapy
MCH	Mean Corpuscular Hemoglobin
MCHC	Mean Corpuscular Hemoglobin Concentration
MCV	Mean Corpuscular Volume
MDI	Metered Dose Inhaler
mITT	Modified Intent-to Treat
ml	Milliliter
MMRC	Modified Medical Research Council
Msec (ms)	Millisecond
NHANES III	Third National Health and Nutrition Examination Survey
NIPPV	Non-invasive Positive Pressure Ventilation Device
NYHA	The New York Heart Association
OTC	Over the counter
PFT	Pulmonary Function Test
PRN	pro re nata, As Needed
QD	quaque die, Once Daily
QID	quater in die; Four Times Daily
QTcF	QT using Fridericia's correction factor
RANS	Reynolds averaged Navier-Stokes
$R_{aw}$	Airway resistance
RV	Residual Volume
SABA	Short-acting Beta Agonist
SAE	Serious Adverse Event
SAP	Statistical Analysis Plan
SBP	Systolic blood pressure
$sG_{aw}$	Specific airway conductance
$siR_{aw}$	Image based Specific airway resistance
$siV_{aw}$	Image based Specific airway volume
SNRI	Serotonin-norepinephrine reuptake inhibitors
SD	Standard Deviation
SOP	Standard Operating Procedure
$sR_{aw}$	Specific airway resistance

SSRI	Selective Serotonin Reuptake Inhibitors
TC	Telephone Call
TCO	The single-breath diffusing capacity of the lungs for carbon monoxide
TEAE	Treatment Emergent Adverse Event
TLC	Total Lung Capacity
TNF $\alpha$	Anti-tumor Necrosis Factor $\alpha$
TP	Treatment Period
TURP	Trans-urethral Resection of Prostate
UA	Upper Airway
US	United States
VA	Alveolar volume
V <sub>bv</sub>	Blood vessel volume

## TRADEMARK INFORMATION

### Trademarks Not Owned By Pearl Therapeutics, Inc.

Aerolizer	Montelukast
Anoro Ellipta	Seebri Breezhaler
Atrovent	Spiriva Handihaler
Bretaris Genuair	Spiolto Respimat
Combivent	Tudorza Pressair
Daxas	Ultibro Breezhaler
Duaklir Genuair	Ventolin
Foradil	Zafirlukast
Incruse Ellipta	

## 1 INTRODUCTION AND STUDY RATIONALE

Chronic obstructive pulmonary disease (COPD) is a leading cause of morbidity and mortality at a global level and recent statistics suggest it will become more prevalent as smoking frequencies rise and the population ages (Calverley, 2003; Feenstra, 2001; Ferrer, 1997; Murray, 1997; Sullivan, 2000). In a systematic review and meta-analysis by Halbert and colleagues, the prevalence of physiologically defined COPD in adults aged  $\geq 40$  years was observed to be 9-10% (Halbert 2003 and Halbert 2006). The causes behind COPD are multifactorial, where various risk factors and environmental stimuli have been identified and include smoking, air pollution, and occupational hazards. Hence, COPD is not only a smoker's disease with familial origins but one that worsens with age.

COPD is a disease of the lungs characterized by airflow limitation that is not fully reversible. The chronic airflow limitation characteristic of COPD is caused by a mixture of small airways disease (obstructive bronchiolitis) and parenchymal destruction (emphysema) the relative contributions of which vary from person to person. The airflow limitation is progressive in nature and associated with an abnormal inflammatory response of the lung to noxious particles or gases. This disease is characterized by premature loss of ventilator function as determined by a decline in forced expiratory volume in the first second of exhalation ( $FEV_1$ ). Pathological inflammatory changes are characterized by elevations in activated macrophages, neutrophils, elastases, and CD8 lymphocytes. These molecular and cellular changes caused the destruction of small airways and surrounding alveoli. As expiratory airflow ( $FEV_1$  or forced vital capacity (FVC)) is a function of pressure against resistance, airflow in COPD is diminished due to a loss of elastic recoil and airway constriction.

Pharmacologic therapy for COPD is used to reduce symptoms, reduce the frequency and severity of exacerbations, and improve health status and exercise tolerance. Bronchodilators are the mainstay of pharmacologic treatment of COPD. The principal bronchodilator treatments are short-acting beta agonists (SABAs), long-acting beta<sub>2</sub> agonists (LABAs), short-acting muscarinic antagonists, long-acting muscarinic antagonists (LAMAs) and methylxanthines used as monotherapy or in combination. In subjects with significant symptoms but low risk of exacerbations, regular treatment with LABAs is more effective in the management of COPD than SABAs. In subjects with a high risk of exacerbations regardless of the number of symptoms, a fixed combination of an inhaled corticosteroid (ICS)/LABA or a LAMA is recommended (GOLD, 2015).

Currently, four fixed-dose combinations of LABA and a LAMA are commercially available in Europe (Duaklir<sup>®</sup> Genuair<sup>®</sup> [aclidinium and formoterol] from Astra Zeneca, Anoro<sup>®</sup> Ellipta<sup>®</sup> [umeclidinium and vilanterol] from [REDACTED], Ultibro<sup>®</sup> Breezhaler<sup>®</sup> [indacaterol and glycopyrronium] from [REDACTED], and Spiolto Respimat<sup>®</sup> [tiotropium and olodaterol] from [REDACTED]). Combivent<sup>®</sup> [salbutamol sulfate and ipratropium bromide] is a short-acting fixed dose combination of a SABA and short-acting muscarinic antagonist indicated for the treatment of COPD and is administered as two inhalations four times daily. Published studies (van Noord, 2005; van Noord, 2006; Vogelmeier, 2006) have shown that the complementary



mechanisms of action of LABA (formoterol fumarate) and a LAMA (tiotropium bromide) significantly improved bronchodilation in COPD subjects compared to the individual agents.

Pearl Therapeutics, Inc. (hereafter referred to as Pearl) is developing a combination product, Glycopyrronium and Formoterol Fumarate Inhalation Aerosol (PT003, hereafter referred to as GFF metered-dose inhaler [MDI]), as a maintenance bronchodilator treatment in subjects with COPD. In this study, GFF MDI 14.4/9.6 µg contains 14.4 µg of glycopyrronium and 9.6 µg of formoterol fumarate. GFF MDI is administered twice daily (BID). The dose of glycopyrronium (14.4 µg) in GFF MDI is equivalent to 18 µg of glycopyrrolate (glycopyrronium bromide).

Glycopyrronium is a LAMA which exerts bronchodilator effect via muscarinic receptors located on smooth muscle cells within the trachea and bronchi. Glycopyrronium is approved in many countries in multiple formulations for different indications, including COPD.

An inhaled formulation of glycopyrronium (Seebri<sup>®</sup> Breezhaler<sup>®</sup> Inhalation Powder, glycopyrronium bromide) was recently approved throughout the European Union (EU), Australia, Canada, and Japan for the management of adult subjects with COPD. The recommended dose is 44 µg (delivered dose of 55 µg of glycopyrronium bromide equivalent to 44 µg of glycopyrronium) administered once daily (QD) using the Seebri Breezhaler inhaler. The clinical development program for Seebri Breezhaler included 12 clinical studies, five Phase I studies, four Phase II clinical studies and three Phase III clinical studies. Overall, the clinical development program included a total of 1361 subjects with COPD exposed to Seebri Breezhaler 44 µg QD with a total of 842 and 428 subjects with COPD exposed to Seebri Breezhaler 44 µg QD for  $\geq 26$  weeks and  $\geq 38$  weeks, respectively [Committee for Medicinal Products for Human Use (CHMP) Assessment Report for Seebri Breezhaler, 2012]. In addition to the published data with Seebri Breezhaler (also referred to as NVA 237), there is also large body of published data evaluating the safety and efficacy of inhaled glycopyrronium in healthy volunteers, subjects with COPD, and subjects with asthma.

Formoterol fumarate is a potent and selective LABA approved in many countries worldwide for use in asthma and COPD. When inhaled, formoterol fumarate acts locally in the lung as a bronchodilator. Formoterol fumarate stimulates  $\beta_2$  adrenoreceptors in the airways, inducing airway smooth muscle relaxation and reducing or preventing bronchoconstriction.

Recently, Pearl has completed 3 pivotal Phase III studies (study PT003006, study PT003007, and study PT003008) on GFF MDI and its components (Glycopyrronium MDI (GP MDI) and Formoterol Fumarate MDI (FF MDI)). An intended therapeutic dose of GFF 14.4/9.6 µg BID was chosen for these studies. Prior to these Phase III studies, Pearl conducted a number of Phase I and Phase II studies to support the dose selection of these Phase III studies. In addition, a thorough QT study and a cardiovascular safety study were conducted to support these Phase III studies.

Study PT003006 and study PT003007 were multicenter studies. Study PT003006 was a randomized, double-blind (study drug, active control and placebo), chronic dosing (24 weeks), placebo-controlled, parallel group, multi-center study to assess the efficacy and safety of GFF MDI, FF MDI, and GP MDI in subjects with moderate to very severe COPD, compared with placebo and Spiriva<sup>®</sup> Handihaler<sup>®</sup> (Tiotropium Bromide 18 µg, Open-Label) as an active

control with sites in United States (US), Australia, and New Zealand. StudyPT003007 was a replicated study of study PT003006 without open-label Spiriva as an active control with sites in the United States (US). Combined total of PT003006 and PT003007 studies include 3718 subjects (2103 subjects from PT003006 and 1615 subjects from PT003007). In these studies, GFF MDI 14.4/9.6 µg, FF MDI 9.6 µg, and GP MDI 14.4 µg were safe, well tolerated with no unexpected safety findings and have demonstrated improvements compared to Placebo MDI in lung function, COPD symptoms, and quality of life as well as COPD exacerbations. Study PT003008 was a 28-week safety extension study of Studies PT003006 and PT003007 to evaluate long-term safety and tolerability of GFF MDI, GP MDI, and FF MDI in subjects with moderate to very severe COPD over a total observation period of 52 weeks and 893 subjects. Open label Spiriva was included as an active control. The subjects continued to remain on their originally assigned treatments from studies PT003006 and PT003007. Subjects in Studies PT003006 and PT003007 assigned to Placebo MDI were not invited to participate in this extension study. In this study, GFF MDI 14.4/9.6 µg demonstrated improvements compared to GP MDI 14.4 µg and FF MDI 9.6 µg in lung function evaluated over the 52-week treatment period; the improvements in lung function observed over the first 24 weeks of the lead in studies (PT003006 or PT003007) were generally consistent through Week 52. Overall, the safety profiles of GFF MDI 14.4/9.6 µg, FF MDI 9.6 µg, or GP MDI 14.4 µg were similar to those observed for other approved LAMAs and LABAs (eg, tiotropium, aclidinium, umeclidinium, vilanterol, olodaterol, and indacaterol). No significant additional safety risks were observed with the combination GFF MDI 14.4/9.6 µg over the individual components, FF MDI 9.6 µg, and GP MDI 14.4 µg, or over Spiriva 18 µg.

A more detailed description of the conducted studies and results can be obtained in the Investigator Brochure (IB).

## 1.1 Study Rationale

The dual-action bronchodilator GFF MDI offers rapid onset of action with the effect persisting over 12 hours. PT003 may offer a significant advantage to subjects in terms of sustained efficacy over 12 hours, complete airway coverage via Pearl's porous particles, along with the reliability of Pearl's MDI dosage form with no co-formulation effect during storage or subject use.

In this study the effects of treatment with GFF MDI compared with Placebo MDI on specific image based airway volumes and resistance in subjects with moderate to severe COPD will be assessed. This imaging methodology will allow an assessment of the extent of airway changes using a long acting bronchodilator combination. Previous studies demonstrated that looking directly at airway volumes and resistance is a more sensitive measure as FEV<sub>1</sub> to evaluate the acute bronchodilating effect of inhaled LABA and/or LAMA (De Backer, 2011; De Backer, 2012; Vos, 2013).

## **2 STUDY OBJECTIVES**

- To assess the efficacy and safety of treatment with GFF MDI (14.4/9.6 µg BID) and Placebo MDI in subjects with moderate to very severe COPD.

### **2.1 Primary Objective**

- To assess the effect of treatment with GFF MDI, twice daily (BID) compared with Placebo MDI on specific image-based airway volumes and resistance in subjects with moderate to severe chronic obstructive pulmonary disease (COPD) following chronic dosing after approximately two weeks treatment.

### **2.2 Secondary Objectives**

- To compare the effects of GFF MDI on various Functional Respiratory Imaging (FRI) parameters.
- To compare the effects of GFF MDI and Placebo MDI on pulmonary function test (PFT) parameters.

### **2.3 Safety Objectives**

- To assess the safety of GFF MDI in subjects with moderate to severe COPD based on Adverse Events (AEs), and any clinically relevant findings from vital sign measurements, electrocardiograms (ECGs), physical examination findings, and clinical laboratory evaluations.

### 3 STUDY ENDPOINTS

#### 3.1 Efficacy Endpoints

The first day of treatment in each Treatment Period (TP) is Day 1 (Visits 2 and 4). On Day 1 of each TP baseline measurements including an inspiratory scan (Total Lung Capacity [TLC] scan) and an expiratory scan (Functional Residual Capacity [FRC] scan) will be conducted. During Visit 2 an additional scan of the upper airway (UA) will be taken. Each TP is planned to contain approximately 2 weeks between the first and last dose corresponding to a span of 15 calendar days ( $\pm 5$  days). Therefore, post dose assessments collected on Day 15 ( $\pm 5$  days) (Visits 3 and 5) will occur following approximately 2 weeks of treatment with GFF MDI or Placebo MDI. Post dose Computed Tomography (CT)-scan (TLC scan) will be taken on Day 15 ( $\pm 5$  days) (Visit 3 and Visit 5).

Lung function measurements and symptom-based endpoints will be evaluated on Day 1 and Day 15 ( $\pm 5$  days) of Treatment Period 1 and 2 (Visits 2, 3, 4 and 5).

##### 3.1.1 Primary Efficacy Endpoints

###### FRI Parameters:

- Specific airway volume ( $_{si}V_{aw}$ )
- Specific airway resistance ( $_{si}R_{aw}$ )

##### 3.1.2 Secondary Efficacy Endpoints

###### FRI Parameters:

- Airway volume ( $iV_{aw}$ )
- Airway resistance ( $iR_{aw}$ )

###### Spirometry Parameters:

- Forced expiratory volume in one second ( $FEV_1$ )

###### Body Plethysmography Parameters:

- FRC

### 3.1.3 Other Efficacy Endpoints

#### **FRI Parameters:**

- Lobe volumes (iVlobes)
- Air trapping
- Internal lobar airflow distribution
- Low attenuation or emphysema score
- Blood vessel density or fibrosis score
- Airway wall thickness
- Mass of deposited particles per defined airway section

#### **Spirometry Parameters:**

- Forced vital capacity (FVC)
- Tiffeneau index (FEV<sub>1</sub>/FVC ratio)
- Forced expiratory flow 25%-75% (FEF<sub>25-75</sub>)
- Inspiratory capacity (IC)

#### **Body Plethysmography Parameters:**

- Residual volume (RV)
- TLC
- Airway resistance (Raw)
- Specific airway resistance (sRaw)
- Specific airway conductance (sGaw)

### 3.2 Safety Endpoints

- AEs

## 4 INVESTIGATIONAL PLAN

### 4.1 Overall Study Design and Plan

This is a single center, chronic dosing (2 weeks) study to assess the effects of GFF MDI (14.4/9.6 µg BID) compared with Placebo MDI in subjects with moderate to severe COPD on specific image based airway volumes and resistance.

In this study 20 subjects will be included with moderate to severe COPD. Subjects will be randomized in two treatment sequences. Subjects in sequence 1 will receive GFF MDI in TP 1 followed by Placebo MDI in TP 2. Subjects in sequence 2 will receive Placebo MDI in TP 1 followed by GFF MDI in TP 2.

Subjects will receive approximately 2 weeks of study treatment with each of their assigned treatments for a total of two separate TPs. A washout period of 5-21 days will occur between each Treatment Period. The entire study period is scheduled to take approximately 13 weeks for each individual subject from the time of Screening.

Prior to or at Visit 1 (Screening), all subjects are to sign an informed consent form prior to the conduct of any screening assessments. The Investigator or designee will obtain a medical history including specific cardiovascular history, COPD exacerbations within the last year, clinical laboratory tests, physical examination, pregnancy test and any required documentation in order to determine eligibility for participation (i.e., inclusion/exclusion criteria). Subjects must meet spirometry criteria for COPD ( $30\% < FEV_1 < 80\%$  predicted and  $FEV_1/FVC$  ratio  $< 0.70$ ) at Visit 1 to qualify for study enrollment. Reversibility of  $FEV_1$  approximately 30-60 minutes following four puffs of Ventolin<sup>®</sup> HFA will be assessed and a ventilation-perfusion relationship measurement (diffusion capacity) will be performed at Screening (Visit 1) to characterize the subject population. Re-screening is not allowed for subjects who do not meet the spirometry criteria at Visit 1.

Providing the subject meets the eligibility criteria, the Investigator or designee will review current COPD medications and, if necessary, will make arrangements to adjust the prohibited COPD therapy to protocol-allowable COPD therapy. At Visit 1 (Screening), eligible subjects who are using a prohibited COPD medication (refer to Table 5-1) and meet all other entry criteria will return to the clinic 7 and to 21 days for Visit 2 (Randomization Visit). For more details on Visit 1 procedures, refer to [Section 8.1](#).

Subjects who meet all entry criteria but are using certain prohibited COPD medications (eg., oral  $\beta_2$ -agonists, LABAs, LAMAs, LABA/LAMA, corticosteroid/LABA combination products, cromoglycate or nedocromil inhalers, leukotriene antagonists [eg., zafirlukast, montelukast] or tiotropium [Spiriva], glycopyrronium [eg., Seebri<sup>®</sup>], and aclidinium [eg., Tudorza<sup>®</sup> Pressair<sup>®</sup>/Bretaris<sup>®</sup> Genuair<sup>®</sup>], umeclidinium [Incruse Ellipta<sup>®</sup>] and fixed dose LAMA/LABA combinations; Duaklir<sup>®</sup> Genuair<sup>®</sup> (aclidinium and formoterol), Anoro<sup>®</sup> (umeclidinium and vilanterol), Ultibro<sup>®</sup> Breezhaler<sup>®</sup> (indacaterol and glycopyrronium), and Spiolto<sup>®</sup> Respimat<sup>®</sup> (tiotropium and olodaterol) will discontinue these medications for the duration of the study. Subjects taking a fixed-dose combination treatment with an ICS plus a LABA must discontinue the combined medication and instead be prescribed an ICS monotherapy at an equivalent dose and regimen for the duration of the study. During the Run-in period, and between Visits 3 and 4,

subjects will use Sponsor-provided Atrovent<sup>®</sup> HFA [[Atrovent, 2012](#)], administered four times daily (QID) (see [Section 6.7.2](#)) and sponsor-provided rescue Ventolin<sup>®</sup> HFA (albuterol sulfate inhalation aerosol) [REDACTED], as needed (PRN), to control symptoms (see [Section 6.7.3](#)). Subjects previously using an ICS and/or phosphodiesterase inhibitor may continue using the medications at the same dose as previously described.

At Visit 1 several key assessments (refer to [Table 8-](#)) shall be obtained. Additionally, dyspnea will be evaluated through the Modified Medical Research Council (MMRC) questionnaire, and the burden of disease will be assessed through the COPD Assessment Test (CAT), therefore, it is necessary for all subjects to be appropriately washed out of their inhaled COPD medications prior to Visit 1 (refer to [Section 5.4.1](#)).

At Visit 2 (Randomization Visit; Day 1 of TP 1), subjects will return to the clinic. Site staff must confirm the subject meets all protocol-specific requirements and ensure adequate washout (6 hours or longer) of all inhaled medications (including ICS, and rescue medication), except for sponsor-provided Atrovent<sup>®</sup> HFA. Subjects who continue to meet entry inclusion/exclusion criteria and remain eligible for participation in the study will be randomized into one of two pre-defined treatment sequences (possible treatment sequences to which a subject can be randomized are shown in [Section 9.4](#)). At Day 1 of Treatment Period 1 (Randomization Visit) each subject will be assigned to either GFF MDI or Placebo MDI. At Day 1 of Treatment Period 2 each subject will be assigned to the opposite treatment to which they were assigned during Treatment Period 1. The Washout Period between Treatment Period 1 and 2 is 5 to 21 days in duration.

At Visit 2 subjects will complete all pre-dose timed assessments and in the beginning of the visit the baseline FEV<sub>1</sub> value will be obtained, refer to [Table 8-10](#) prior to receiving their first dose of GFF MDI or Placebo MDI in the clinic under site personnel supervision. During the pre-dose assessments a scan of the upper airway (UA) will be taken. After the CT-scans are taken, spirometry and body plethysmography will be performed; the inhalation profile will be measured with the body plethysmograph and respiration belts. The subject's inhalation profile will be measured in order to draw an airflow versus time curve. At the moment of this measurement the signal from the respiration belt, used for the measurement of the inhalation profile during the study drug administration, will also be logged.

Prior to MDI administration on Day 1 of treatment period 1 and 2, the MDI device will be primed (four actuations to waste) at the study site by the study team in a room separated from the patient. After administration of the subject's first dose, all post-dose assessments will be performed, refer to [Table 8-10](#). Following completion of all assessments, subjects will be discharged from the clinic and will be instructed to continue to administer Treatment period 1 study drug for approximately 2 weeks at home until Visit 3.

For more details on Visit 2 procedures, refer to [Section 8.2](#).

The subject, clinical site personnel, and Pearl will be unaware of the treatment sequence assigned to a subject; it will not be possible to differentiate between GFF and Placebo MDIs since they will be identical in all aspects. The GFF and Placebo MDIs will be administered BID.



Subjects will be trained on how to read the dose indicator. See [Section 7.1.9](#) and [Appendix 6](#) for instructions on how and when to read the dose indicator.

On Visit 3 (Day 15  $\pm$  5 of TP 1) subjects will perform a spirometry test and will undergo Visit 3 protocol-defined pre-dose assessments (refer to [Table 8-](#) and [Table 8-11](#)). The site personnel will wait 1 hour after the administration of study drug before initiating post-dose assessments. Post-dose assessments need to be completed within 2.5 hours after dosing the subject. Study drug will be collected. Prior to discharge from the study clinic, subjects will be instructed to undergo a washout period of 5 to 21 days, while on Sponsor-provided Atrovent HFA MDI, administered QID and Ventolin HFA for rescue use, as needed (PRN) prior to initiating the next treatment in their assigned treatment sequence. For more details on Visit 3 procedures, refer to [Section 8.3](#) and [Table 8-11](#).

At Visit 4 (Day 1 of TP 2) it is important to ensure that the baseline FEV<sub>1</sub> is stable and reflective of the subject's COPD severity prior to continuing to the second treatment period. As such the baseline stability criteria will be evaluated (see section 5.1). To ensure baseline FEV<sub>1</sub> stability at Visit 4 the -60 minute FEV<sub>1</sub> value obtained at Visit 4 will be compared to the average predose (-60 and -30 minute) FEV<sub>1</sub> values obtained at Visit 2. Subjects meeting baseline stability criteria will be dispensed treatment period 2 study drug according to their assigned treatment sequence and will administer their first dose in the clinic under site personnel supervision. Subjects will undergo all protocol-defined assessments (see [Table 8-](#) and [Table 8-10](#)), will be discharged from the clinic, and will be instructed to continue study drug administration for approximately 2 weeks (14 days  $\pm$  5 days) until Visit 5. For more details on Visit 4 procedures, refer to [Section 8.4](#) and [Table 8-](#).

At Visit 5 (Day 15  $\pm$  5 days of TP 2) subjects will again return to the clinic for administration of the final dose of TP 2 study drug under site personnel supervision. Visit 5 will serve as the final clinic visit. Prior to the administration of the final dose of study drug subjects will perform a spirometry test and will undergo Visit 5 protocol-defined pre-dose assessments (see [Table 8-](#) and [Table 8-11](#)). The site personnel will wait 1 hour after the administration of study drug before initiating post-dose assessments. Post-dose assessments need to be completed within 2.5 hours after dosing the subject. Study drug will be collected, subjects returned to pre-study or appropriate maintenance COPD medications, and subjects will be discharged from the study. A telephone follow-up will be performed within 7 to 10 days following Visit 5. For more details on Visit 5 procedures, refer to [Section 8.5](#) and [Table 8-11](#).

Refer to [Table 8-](#) for the overview of the study procedures and assessments to be performed at the study visits.

#### **4.1.1 General Considerations for Treatment Visit 2 through Visit 5 (in-clinic):**

- At the start of each treatment period (Visit 2 and Visit 4), prior to any study procedures being performed, site personnel must confirm the subject withheld all inhaled COPD medications (including ICS and rescue medication, eg, Ventolin HFA), except sponsor-provided Atrovent<sup>®</sup> HFA for at least 6 hours, by confirming the last time of dosing for all COPD medication(s).



**Note:** Subjects who inadvertently took COPD medication(s) (except for sponsor-provided Atrovent<sup>®</sup> HFA) within 6 hours of the start of study procedures must be rescheduled as soon as is practical but within the specified visit window.

**Note:** Before the in-clinic dose is administered, the site must confirm the subject meets all other protocol-specified requirements.

**Note:** Subjects will be instructed to administer sponsor-provided Atrovent<sup>®</sup> HFA the morning of Visit 2 and Visit 4 5-6 hours prior to the anticipated time of the post-dose CT scan.

- At the end of each treatment period (Visit 3 and Visit 5), prior to any study procedures being performed, site personnel must confirm the subject withheld all inhaled COPD medications (including randomized study medication, ICS and rescue medication, eg, Ventolin HFA) for at least 6 hours, by confirming the last time of dosing for all COPD medication(s).

**Note:** Subjects who inadvertently took inhaled COPD medication(s) within 6 hours of the start of study procedures must be rescheduled as soon as is practical but within the specified visit window.

**Note:** Before the in-clinic dose is administered, the site must confirm the subject meets all other protocol-specified requirements.

- Subjects must not ingest xanthine-containing foods and beverages for at least 6 hours prior to each study visit and for the duration of each study visit (see [Section 5.5.2](#)).
- Subjects will be required to refrain from smoking (nicotine gums and patches are allowed) for at least 4 hours prior to each study visit and throughout the duration of each study visit.
- To ensure standardization of dosing times, it is recommended the site encourage subjects to maintain a dosing schedule at home consistent with their in-clinic dosing time.

Subjects will be required to take their study drug BID in the morning between 07:00 and 11:00 am (breakfast time) and in the evening between 07:00 and 11:00 pm (dinner time).

- In order to minimize diurnal variance, sites should discuss the importance with the subject of dosing in a timely manner every 12 hours for blinded study medication.
- In order to minimize diurnal variance, sites should make every effort to assess subjects at the same time throughout the study.

Subjects will be required to return to the clinic at approximately the same time for all treatment visits and will be required to remain at the clinic until completion of all protocol-defined assessments.

- The site should make every effort to ensure that the in-clinic dosing time for BID treatment occurs around 11:00 am and within 12±2 hours of the prior at-home evening dosing time. Sites are encouraged to call the subject on the day before a scheduled visit to remind the subject of the following:

To take their last dose of BID treatments the evening before the scheduled visit at approximately 11pm.

To bring their study drug, sponsor-provided Atrovent<sup>®</sup> HFA and sponsor-provided Ventolin<sup>®</sup> HFA with them to the clinic.

To administer sponsor-provided Atrovent<sup>®</sup> HFA the morning of Visit 2 and Visit 4 5-6 hours prior to the anticipated time of the post-dose CT scan.

To withhold all inhaled COPD medications (including randomized study drug, ICS, and rescue medication) for at least 6 hours prior to study assessments with the exception of sponsor-provided Atrovent<sup>®</sup> HFA at Visit 2 and Visit 4.

To refrain from ingesting xanthine-containing foods and beverages for at least 6 hours prior to each study visit and for the duration of each study visit.

To refrain from smoking for at least 4 hours prior to the study visit and throughout the duration of each study visit.

- The in-clinic dosing time will be recorded as the time of administration of the second puff of study drug.
- Site personnel will instruct subjects not to take any non-study COPD medications, without site personnel permission, during a visit until all study procedures have been completed and the subject is discharged from the clinic. Site personnel should take every precaution to prevent use of non-study inhaled COPD medications during a test day. Site personnel may request the subject to surrender all non-study COPD medications prior to the start of the visit before performing any study procedures and return the medications to the subject at the end of the visit when all study procedures are completed if the Investigator is of the opinion this is needed.
- If a subject is experiencing severe symptoms and requires Ventolin HFA for relief of COPD symptoms at any time during a test day, site personnel must note the time and justification for use in the subject's worksheet and all subsequent spirometry assessments should be stopped. However, safety assessments should be continued at the discretion of the Investigator.
- Every effort must be made to ensure that subjects return to the clinic on Day 15 following the initiation of each treatment period. To accommodate scheduling conflicts, a window of ± 5 days is permitted (i.e., Day 15 procedures must be done within a minimum of 10 days and a maximum of 20 days from Day 1).

During each TP (Visits 2 to 3, and Visits 4 to 5), subjects will be permitted to use Sponsor-provided Ventolin HFA on an as-needed basis for relief of COPD symptoms.

During the run-in period and washout period, when subjects are not taking study drug (Visits 1 to 2, and Visits 3 to 4), subjects will use the Sponsor-provided short-acting bronchodilator (Atrovent HFA) administered QID and may use Ventolin HFA on an as-needed basis.

Protocol-adjusted ICS therapy defined at Screening, if any, should be continued and remain stable for the duration of the study (see [Section 5.4](#) for further guidance related to phosphodiesterase inhibitors).

A Study Flow Diagram is displayed in [Figure 1](#).

**Figure 1 Study Design Chart**

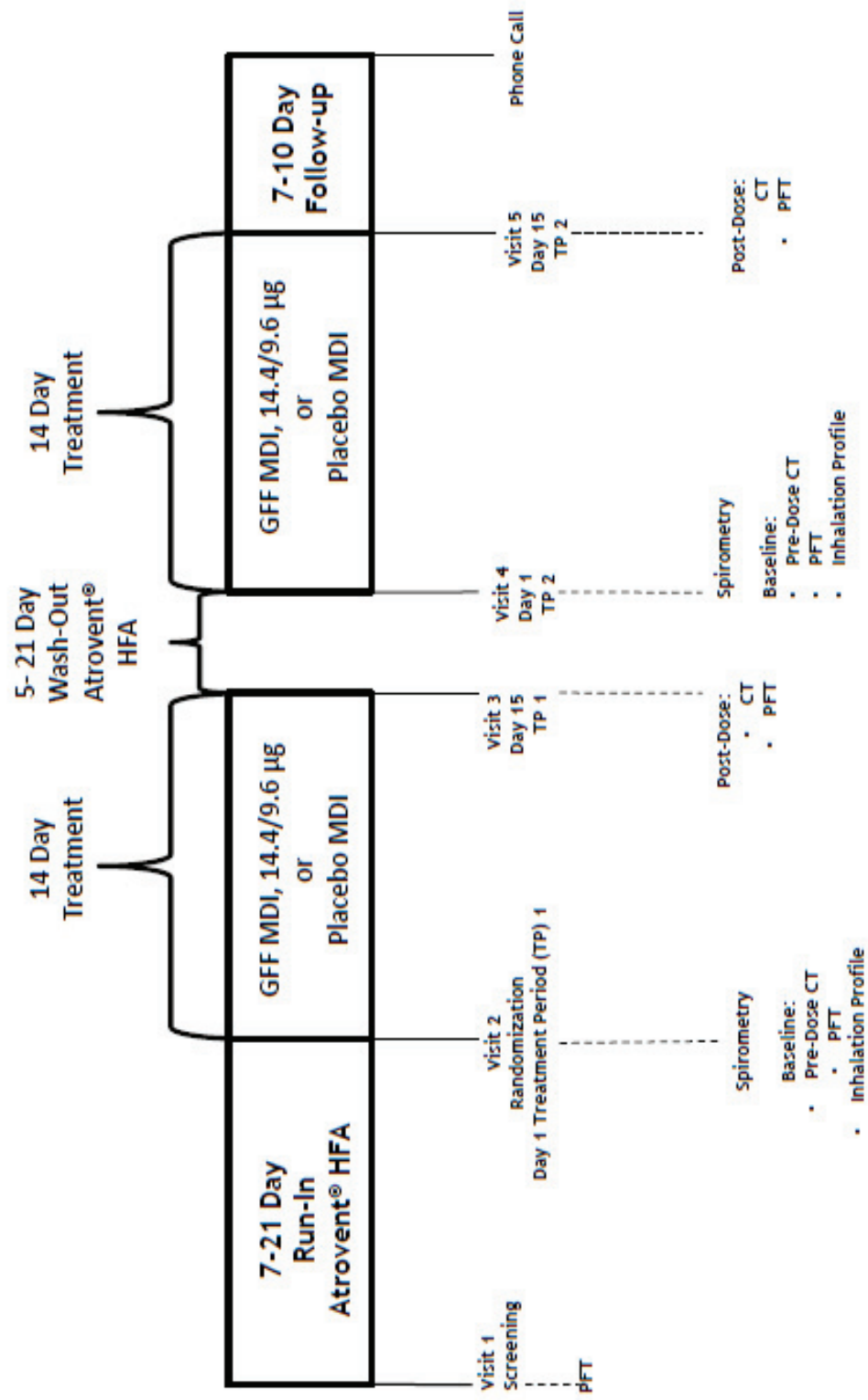

## 4.2 Rationale of Study Design

This study will assess the effects of GFF MDI 14.4/9.6 µg administered BID compared to Placebo MDI on specific image based airway volumes and resistance.

A randomized, double-blind, cross-over design was adopted in order to increase the precision of comparisons between treatment groups.

## 4.3 Rationale of Dose/Regimen, Duration of Treatment, and Placebo Arm

The selection of the GFF MDI (14.4/9.6 µg BID) dose in this study was based on data from the findings of three previous dose-ranging studies with GP MDI (Studies PT0010801, PT001002, and PT001003), two dose-ranging clinical studies with FF MDI (Studies PT0050801 and PT005003), and four studies with GFF MDI (Studies PT0031002, PT003003, PT003004, and PT003005).

These programs identified the optimal doses as 9.6 µg BID for FF MDI and 14.4 µg BID for GP MDI. The aforementioned studies also showed that Glycopyrronium 14.4 µg when added to formoterol fumarate 9.6 µg provides a reasonable benefit across all parameters. GFF MDI 14.4/9.6 µg was safe and well-tolerated with an AE profile similar to its components and other approved products for the management of COPD (ie, Spiriva, Atrovent, and Foradil<sup>®</sup> Aerolizer<sup>®</sup>).

The study will evaluate the effects of GFF MDI and Placebo MDI on specific image based airway volumes and resistance, other various FRI parameters, lung function tests over 2 weeks.

A Placebo MDI arm will be included in the trial. The Placebo MDI arm does not imply that this cohort is untreated. Subjects will be permitted to receive maintenance ICS, and/or phosphodiesterase inhibitors if they were on a stable dose of these medications prior to enrolling in the study, and Ventolin HFA MDI will be provided as rescue medication. No currently approved treatment prevents death or irreversible morbidity by influencing the course of disease.

With respect to exacerbations, changing an ICS/LABA to an ICS and PRN Ventolin<sup>®</sup> HFA MDI or changing Spiriva, Seebri to PRN Ventolin<sup>®</sup> HFA is unlikely to cause significant short-term harm. There are three further safeguards to ensure subject safety in this study. First, Roflumilast (Daxas<sup>®</sup>), a recently approved drug to prevent COPD exacerbations, is a permissible medication throughout the course of the study provided the subject was on a stable dose prior to enrollment. Second, subjects experiencing exacerbation that requires treatment with oral corticosteroids or antibiotics within 6 weeks prior to Visit 1 (Screening) or during the run-in period (Visit 1 to Visit 2) will be discontinued from the trial. Third, subjects experiencing a COPD exacerbation during the treatment periods or during the wash-out between treatment periods requiring oral, intramuscular or intravenous corticosteroids and/or antibiotics should be prematurely discontinued from the study.

## 5 STUDY POPULATION SELECTION AND WITHDRAWAL CRITERIA

### 5.1 Inclusion Criteria

Subjects eligible for enrolment in the study must meet all of the following criteria:

1. Give their signed written informed consent to participate.
2. Are at least 40 years of age and no older than 80 at Visit 1.
3. A female is eligible to enter and participate in the study if she is of:
  - Non-child bearing potential (ie, physiologically incapable of becoming pregnant, including any female who is 2 years post-menopausal); or
  - Child bearing potential, has a negative urine pregnancy test at Visit 1, and agrees to one of the following acceptable contraceptive methods used consistently and correctly as outlined below (ie, in accordance with the approved product label and the instructions of the physician for the duration of the study) from Visit 1 (Screening) until 14 days after Visit 5.:
    - Complete abstinence from intercourse; or
    - Implants of levonorgestrel inserted for at least 1 month prior to the study drug administration but not beyond the third successive year following insertion; or
    - Injectable progestogen administered for at least 1 month prior to study drug administration; or
    - Oral contraceptive (combined or progestogen only) administered for at least one monthly cycle prior to study drug administration; or
    - Double barrier method: condom or occlusive cap (diaphragm or cervical/vault caps) plus spermicidal agent (foam/gel/film/cream/suppository); or
    - An intrauterine device (IUD), inserted by a qualified physician, with published data showing that the highest expected failure rate is less than 1% per year; or
    - Estrogenic vaginal ring; or
    - Percutaneous contraceptive patches.
4. A Male is eligible to enter and participate in the study if he is willing not to father a child during the study.
5. COPD Diagnosis: Subjects with an established clinical history of COPD as defined by the American Thoracic Society (ATS)/European Respiratory Society (ERS) (Celli, 2004) characterized by:
  - Airflow limitation that is not fully reversible. Progressive airflow limitation associated with an abnormal inflammatory response of the lungs to noxious particles or gases, primarily caused by cigarette smoking.
6. Tobacco Use: Current or former smokers with a history of at least 10 pack-years of cigarette smoking. [Number of pack-years = (number of cigarettes per day / 20) x number of years smoked (eg, 20 cigarettes per day for 10 years, or 10 cigarettes per day for 20 years represent 10 pack-years)].

7. Severity of Disease: Subjects with an established clinical history of COPD and severity defined as:
  - At Visit 1 pre-bronchodilator FEV<sub>1</sub>/FVC ratio of <0.70.
  - At Visit 1 post-bronchodilator FEV<sub>1</sub> must be >30% and <80% predicted normal value, calculated using The Third National Health and Nutrition Examination Survey (NHANES III) reference equations.
8. Stability criteria:

At Visit 4 if the pre-dose -60 minute FEV<sub>1</sub> value is outside of the ±20% range compared to the average (-30 and -60 minute) pre-dose FEV<sub>1</sub> value of Visit 2, the visit may be rescheduled at the Investigator's discretion, or the subject may be discontinued.
9. Subject is willing and, in the opinion of the Investigator, able to adjust current COPD therapy as required by the protocol.
10. Screening clinical laboratory tests must be acceptable to the Investigator.
11. Screening ECG must be acceptable to the Investigator.
12. Chest X-ray or CT-scan of the chest/lungs within 6 months prior to Visit 1 must be acceptable to the Investigator. Subjects who have a chest X-ray (or CT scan) that reveals clinically significant abnormalities not believed to be due to the presence of COPD should not be included. A chest X-ray must be conducted at Visit 1 if the most recent chest X-ray or CT scan is more than 6 months old at the time of Visit 1.
13. Compliance: Subjects must be willing to remain at the study center as required per protocol to complete all visit assessments.

## 5.2 Exclusion Criteria

Subjects meeting any of the following criteria are to be excluded:

1. Significant diseases other than COPD, i.e., disease or condition which, in the opinion of the Investigator, may put the subject at risk because of participation in the study or may influence either the results of the study or the subject's ability to participate in the study.
2. Pregnancy: Women who are pregnant or lactating.
3. Males who intend to father a child during the study.
4. Respiratory:
  - a) Asthma: Subjects, who in the opinion of the Investigator, have a current diagnosis of asthma.
  - b) Alpha-1 Antitrypsin Deficiency: Subjects who have alpha-1 antitrypsin deficiency as the cause of COPD.
  - c) Other Respiratory Disorders: Subjects who have other active pulmonary disease such as active tuberculosis, lung cancer, bronchiectasis (High Resolution Computed Tomography (HRCT) evidence of bronchiectasis that causes repeated acute exacerbations), sarcoidosis, idiopathic interstitial pulmonary fibrosis (IPF),



primary pulmonary hypertension, or uncontrolled sleep apnea (i.e., in the opinion of the Investigator severity of the disorder would impact the conduct of the study).

**Note:** Allergic rhinitis is not exclusionary.

- d) Lung Volume Reduction: Subjects who have undergone lung volume reduction surgery, lobectomy or bronchoscopic lung volume reduction (endobronchial blockers, airway bypass, endobronchial valves, thermal vapor ablation, biological sealants, and airway implants) within 1 year of Visit 1.
- e) Hospitalization: Subjects who have been hospitalized due to poorly controlled COPD within 3 months prior to Visit 1 (Screening) or during the run-in period (Visit 1 to Visit 2).
- f) Poorly Controlled COPD: Subjects who have poorly controlled COPD, defined as acute worsening of COPD that requires treatment with oral corticosteroids or antibiotics within 6 weeks prior to Visit 1 (Screening) or during the run-in period (Visit 1 to Visit 2).

**Note:** Subjects who are steroid dependent and maintained on an equivalent of 5 mg prednisone per day or 10 mg every other day for at least 3 months prior to Visit 1 are eligible for enrollment providing the dose of oral steroids remains stable during the run-in period (Visit 1 through Visit 2).

- g) Lower Respiratory Tract Infection: Subjects who had lower respiratory tract infections that required antibiotics and/or oral steroids within 6 weeks prior to Visit 1 (Screening) or during the run-in period (Visit 1 to Visit 2).
- h) Spirometry Performance:
  - 1) Acceptability: Subjects who cannot perform acceptable spirometry, i.e., meet ATS/ERS acceptability criteria.
  - 2) Repeatability: Subjects who cannot perform technically acceptable spirometry with at least three acceptable flow-volume curves with two or more meeting ATS repeatability criteria for FEV<sub>1</sub> during the pre-bronchodilator assessments at Visit 1 and at the post-bronchodilator assessment at Visit 1.
- i) Oxygen: Subjects receiving long-term-oxygen therapy (LTOT) or nocturnal oxygen therapy required for greater than 12 hours a day.

**Note:** PRN oxygen use is not exclusionary.

- j) Subject use of any non-invasive positive pressure ventilation device (NIPPV).

**Note:** Subjects using continuous positive airway pressure (CPAP) or bilevel positive airway pressure (BiPAP) for Sleep Apnea Syndrome are allowed in the study.
- k) Change in smoking status (ie, start or stop smoking,) or initiation of a smoking cessation program within 6 weeks of Visit 1 and throughout the run-in period (Visit 1 to Visit 2).
- l) Pulmonary Rehabilitation: Subjects who have participated in the acute phase of a pulmonary rehabilitation program within 4 weeks prior to Visit 1 (Screening) or who will enter the acute phase of a pulmonary rehabilitation program during the



study. Subjects who are in the maintenance phase of a pulmonary rehabilitation program are not to be excluded.

- m) Subjects who have initiated or altered the dose regimen of intranasal corticosteroids, intranasal antihistamines, or a combination thereof within 7 days prior to Visit 1 or during the run-in period (Visit 1 to Visit 2)
5. Cardiac disease:
- a) Subjects who have unstable ischemic heart disease, left ventricular failure, or documented myocardial infarction within 12 months of Screening (Visit 1). Subjects with a recent history of acute coronary syndrome, or who have undergone percutaneous coronary intervention or coronary artery bypass graft within the past 3 months are to be excluded.
  - b) Subjects with congestive heart failure (CHF) The New York Heart Association (NYHA) Class III/IV).
  - c) Clinically significant abnormal ECG: A clinically significant abnormal ECG is defined as (but not limited to) any of the following:
    - 1) Clinically significant conduction abnormalities [eg, left bundle branch block, Wolff-Parkinson-White syndrome or evidence of second degree (Mobitz Type II) or third degree atrioventricular (AV) block].
    - 2) Clinically significant arrhythmias (eg, atrial fibrillation with irregular ventricular response, atrial flutter, ventricular tachycardia).  
**Note:** Atrial fibrillation that has been clinically stable for at least 6 months is appropriately treated with anticoagulation and controlled with a rate control strategy (ie, selective beta blocker, calcium channel blocker, digoxin or ablation therapy) for at least 6 months is allowed for inclusion. In such subjects, atrial fibrillation must be present at pre-randomization visits, with a resting ventricular rate <100 beats per minute (bpm). At screening, the atrial fibrillation must be confirmed by central reading.
    - 3) A mean corrected QT interval using Fridericia's correction factor (QTcF) value at screening >450 msec for males and >470 msec for females or an ECG that is not suitable for QT measurements (eg, poorly defined termination of the T wave) at Visit 1 that remains elevated on repeat testing prior to Visit 2.
    - 4) Ventricular rate <45 bpm.
    - 5) Pathological Q waves of  $\leq 1$  year.
    - 6) ST- T wave abnormalities deemed to be clinically significant by the Investigator.  
**Note:** Subjects with non-specific ST-T wave abnormalities that are not deemed clinically significant (per Investigator) are allowed.
    - 7) Any other ECG abnormalities not listed above that in the opinion of the Investigator are clinically significant.
    - 8) Clinically Uncontrolled Hypertension: Subjects who have clinically significant uncontrolled hypertension.

6. Neurological

- a) Subjects with seizures requiring anticonvulsants within 12 months prior to Visit 1 (Screening).

**Note:** Subjects treated with anticonvulsant medication for 12 months or more with no seizure events are eligible.

- b) Subjects taking selective serotonin reuptake inhibitors (SSRIs) or serotonin-norepinephrine reuptake inhibitors (SNRIs) whose dose has not been stable for at least four weeks prior to Visit 1 or is altered at any point during the Run-in Period (Visit 1 to Visit 2), or exceeds the maximum recommended dose.

7. Renal

- a) Subjects with symptomatic prostatic hypertrophy that is clinically significant in the opinion of the Investigator. Subjects with a trans-urethral resection of prostate (TURP) or full resection of the prostate within 6 months prior to Visit 1 are excluded from the study.

- b) Subjects with bladder neck obstruction or urinary retention that is clinically significant in the opinion of the Investigator.

- c) Subjects with a calculated creatinine clearance  $< 30 \text{ ml/min/1.73 m}^2$  estimated using the Modification of Diet in Renal Disease Equation ( $\text{eGFR}_{\text{MDRD}}$ ) at Visit 1 and on repeat testing prior to Visit 2.

**Note:** Subjects with a confirmed calculated creatinine clearance  $< 30 \text{ ml/min/1.73 m}^2$  estimated using the Modification of Diet in Renal Disease Equation ( $\text{eGFR}_{\text{MDRD}}$ ) repeated prior to Visit 2 will not be randomized in the study.

**Note:** Subjects with overactive bladder syndrome treated with oral anticholinergics that have been on treatment for at least one month are allowed in the Study.

8. Endocrine

- a) Subjects, who in the opinion of the Investigator, have uncontrolled hypo- or hyperthyroidism, hypokalemia or hyperadrenergic state.

- b) Subjects, who in the opinion of the Investigator, have uncontrolled Type I or II diabetes.

9. Liver: Subjects with abnormal liver function tests defined as Alanine aminotransferase (AST), Aspartate aminotransferase (ALT), or total bilirubin  $\geq 1.5$  times upper limit of normal at Visit 1 and on repeat testing prior to Visit 2.

10. Cancer: Subjects who have cancer that has not been in complete remission for at least five years.

**Note:** Subjects with squamous cell carcinoma of the skin, basal cell carcinoma of the skin, or localized prostate cancer are eligible, if in the opinion of the Investigator, the condition has been adequately evaluated, is clinically controlled and the subject's participation in the study would not represent a safety concern.

11. Glaucoma: Subjects with a diagnosis of angle closure glaucoma will be excluded, regardless of whether or not they have been treated. Subjects with a diagnosis of open angle glaucoma who have intraocular pressure controlled with medication(s) are eligible. All medications approved for control of intraocular pressures are allowed including topical ophthalmic non-selective  $\beta$ -blockers such as betaxolol, carteolol, levobunolol, metipranolol, or timolol.
12. Drug Allergy: Subjects who have a history of hypersensitivity to  $\beta$ 2-agonists, glycopyrronium or other muscarinic anticholinergics, or any component of the MDI.
13. Substance Abuse: Subjects, who in the opinion of the Investigator, significantly abuse alcohol or drugs (refer to Exclusion Criterion 1).
14. Medication prior to spirometry: Subjects who are medically unable to withhold their short-acting bronchodilators for the 6-hour period required prior to spirometry testing at each study visit will be excluded.
15. Prohibited Medications: Subjects who, in the opinion of the Investigator, would be unable to abstain from protocol-defined prohibited medications during the Screening Period and treatment phases of this study (refer to [Section 5.4](#)).
16. Vaccinations: Subjects who received a live attenuated vaccination within 30 days prior to Visit 1 (Screening) or during the Run-in Period (between Visit 1 and Visit 2).  
**Note:** Inactivated influenza vaccination, pneumococcal vaccination or any other inactivated vaccine is acceptable provided it is not administered within 48 hours prior to Visit 1 (Screening) or Visit 2 (Randomization).
17. Non-compliance: Subjects unable to comply with study procedures.
18. Affiliations with Investigator site: Study Investigators, sub-Investigators, study coordinators, employees of a participating Investigator or immediate family members of the aforementioned are excluded from participation in this study.
19. Questionable Validity of Consent: Subjects with a history of psychiatric disease, intellectual deficiency, poor motivation, substance abuse (including drug and alcohol), or other conditions that will limit the validity of informed consent to participate in the study.
20. Investigational Drugs or Devices: Treatment with investigational study drug or device in another clinical trial within the last 30 days or five half-lives prior to Visit 1 (Screening), whichever is longer.  
**Note:** Subject participation in observational studies (ie, studies that do not require change to medication or an additional intervention) is not exclusionary.
21. Hand-to-Breath Coordination: Subjects who requires the use of a spacer device to compensate for poor hand-to-breath coordination with a MDI.  
**Note:** Use of a nebulizer to deliver COPD medications is prohibited throughout the trial.
22. Previous Participation: Subjects who were previously enrolled in any trial conducted or sponsored by Pearl.

### **5.3 Subject Identification**

All subjects who undergo screening will be assigned a unique screening identification number at the Screening (Visit 1). Only subjects continuing to meet entry inclusion/exclusion criteria at Visit 2 will be assigned a unique subject randomization number.

### **5.4 Prior, Concomitant, and Prohibited Medications**

All prescription and over-the-counter (OTC) medications taken by the subject within 30 days before Visit 1 (Screening) will be recorded on the prior/concomitant medications electronic Case Report Form (eCRF). Any additions, deletions, or changes in the dose of these medications while in the study should be entered on the eCRF. Any current ongoing medications, including OTC drugs and herbal supplements, will be allowed provided they are not prohibited by the protocol (refer to [Section 5.4.2](#)) and are approved by the Investigator. Subjects should also be instructed to contact the Investigator if they develop any illnesses.

All concomitant medications taken during the study will be recorded on the Concomitant Medications eCRF with indication, dose, dose regimen, and dates of drug administration.

#### **5.4.1 Prohibited COPD Medications**

The following medications used for the treatment of COPD are not permitted during this study. These medications must be discontinued 6 hours to 24 hours prior to Visit 1 (Screening) and are not permitted during the run-in period. The minimum washout period before Visit 1 and between Visit 1 and Visit 2 are shown in [Table 5-1](#). The only COPD medications permitted during the study are sponsor-provided Atrovent HFA<sup>®</sup> for COPD maintenance during the run-in and wash-out period and sponsor-provided Ventolin HFA<sup>®</sup> for rescue of COPD symptoms during the study.

**Table 5-1 Prohibited COPD Medications and Required Washout Periods Prior to Visit 1 and Visit 2**

Class of Medication	Minimum Washout Period Prior to:	
	Visit 1	Visit 2
LAMAs	24 hours	Tiotropium: 14 days Aclidinium: 7 days Glycopyrronium: 7 days Umeclidinium: 7 days
Short-acting muscarinic antagonists (SAMA) <sup>a</sup>	6 hours	6 hours
LABAs (inhaled)	24 hours	48 hours (Indacaterol: 15 days)
Fixed-combinations of LABA/LAMA	24 hours	7 days (15 days for indacaterol/glycopyrronium and olodaterol/tiotropium)
Fixed-combinations of LABA/ICS	24 hours	7 days
Fixed-combinations of SABAs and SAMAs	6 hours	6 hours
SABAs <sup>b</sup>	6 hours	6 hours
Oral $\beta$ -agonists		2 days
Theophylline (total daily dose >400 mg/day) <sup>c</sup>		7 days
Monotherapy of ICS		6 hours

Abbreviations: COPD=chronic obstructive pulmonary disease; HFA=hydrofluoroalkane; ICS=inhaled corticosteroid; LABA=long-acting  $\beta_2$ -agonist; LAMA=long-acting muscarinic antagonist; SABA=short-acting  $\beta_2$ -agonist

Note: Subjects taking roflumilast are allowed provided they have been on stable dose of therapy for at least 2 months prior to Randomization.

- a. Discontinue and use only sponsor-provided Atrovent HFA during screening
- b. Discontinue and use only sponsor-provided rescue Ventolin HFA throughout the study
- c. Theophylline ( $\leq 400$  mg/day) is permitted provided the subject has been on a stable dose of therapy for at least 4 weeks prior to Randomization.

Subjects that have received depot corticosteroids including, intra-articular or intraocular corticosteroids require a 3 month washout prior to Visit 1. Subjects that have received oral, intravenous or intramuscular corticosteroids for any reason require a 6 week washout prior to Visit 1. Any subject that requires use of systemic corticosteroids during the run-in period (Visit 1 to Visit 2) will be screen failed.

**Note:**

- Subjects who are steroid dependent and maintained on an equivalent of  $\leq 5$  mg oral prednisone per day or  $\leq 10$  mg oral prednisone every other day for at least 3 months prior to Visit 1 are eligible providing the dose of oral steroids remains stable during the run-in period (Visit 1-Visit 2).
- During the treatment periods (Visit 2 to Visit 3 and Visit 4 to Visit 5), subjects treated with oral corticosteroids and/ or antibiotics for exacerbation should be discontinued from the study.

Subjects who meet all entry criteria but are using one or more of the prohibited COPD medications (previously listed) will have their maintenance therapy for COPD adjusted as follows:

- Subjects taking prohibited COPD medications (listed previously) at Visit 1 (Screening) will discontinue these medications 6 to 24 hours before Visit 1 for the duration of the trial. At Visit 1 subjects will and be switched to sponsor-provided Atrovent HFA MDI administered QID and sponsor-provided Ventolin HFA to be administered up to four times per day as needed (PRN) for control of symptoms during the run-in period.
- Subjects receiving a maintenance dose of an ICS as part of a fixed dose combination therapy containing fluticasone and salmeterol, mometasone and formoterol, budesonide and formoterol or fluticasone and formoterol must have been on the ICS component and on a stable dose for at least 4 weeks prior to Visit 1 (Screening) and maintained on a stable dose for at least 4 weeks prior to Visit 1 (Screening). At Visit 1 these subjects will be switched to the corresponding dose of fluticasone, mometasone or budesonide administered as a single agent BID, with sponsor-provided Atrovent HFA MDI administered QID, and sponsor-provided Ventolin HFA to be administered up to four times per day, as needed (PRN) for control of symptoms during the run-in period.
- Subjects receiving a maintenance dose of an ICS that is not administered as a fixed-dose combination together with a LABA will be permitted to continue the ICS provided they have been maintained on a stable dose for at least 4 weeks prior to Visit 1 (Screening).
- All subjects treated with either a LABA (salmeterol, formoterol, indacaterol) or currently marketed LAMA (tiotropium, aclidinium, glycopyrronium, [eg, Seebri]) administered alone or as a loose combination will have these medications discontinued and replaced with sponsor-provided Atrovent HFA MDI administered QID, and sponsor-provided Ventolin HFA to be administered up to four times per day, as needed (PRN) for control of symptoms during the run-in period.
- At Visit 1, subjects who meet all entry criteria and are taking prohibited COPD medications in Table 5-1 will start with sponsor-provided Atrovent HFA MDI administered QID for COPD maintenance, and sponsor-provided Ventolin HFA to be administered up to four times per day, as needed (PRN) for control of symptoms during the run-in period

The following respiratory medications are not permitted during this study ([Table 5-2](#))

**Table 5-2: Other Respiratory/Nasal Medications: Required Washout Periods**

<b>Required washout periods prior to Visit 2:</b>	
<b>Class of medication</b>	<b>Minimum cessation period prior to Visit 2</b>
Leukotriene antagonists (eg, zafirlukast, montelukast)	7 days
Cromoglycate	7 days
Nedocromil	7 days
Ketotifen *	7 days

\*Ketotifen eye drops are allowed

### 5.4.2 Other Prohibited Medications

The following medications should be used under the stated conditions during this study (Table 5-3). Each concomitant drug must be individually assessed against all exclusion criteria. If in doubt, the Investigator should contact the sponsor before randomizing a subject or allowing a new medication to be started:

**Table 5-3: Non-COPD Medications Allowed Under Certain Condition**

<b>Medications allowed under certain conditions</b>	<b>Condition</b>
SSRIs or SNRIs	Treatment regimen has been stable for at least four weeks prior to Visit 1 and not altered during the run-in period and does not exceed the maximum recommended dose
Intranasal corticosteroids, intranasal antihistamines or combination thereof	Administered at constant dose and dosing regimen for at least 7 days prior to Visit 1 (Screening) and during the run-in period

Subjects requiring the following medications are prohibited from this study (Table 5-4). Subjects who recently discontinued use of these medications may be considered for study enrollment providing they have met the minimum washout period prior to Visit 1 (Screening). These medications are prohibited throughout the course of the study, and, should a subject require use of any of the listed medications, they should be discontinued.



**Table 5-4: Prohibited Medications**

<b>Prohibited medications</b>	<b>Minimum cessation period prior to Visit 1 (Screening)</b>
Any drug with potential to significantly prolong the QT interval	14 days or 5 half-lives, whichever is longer
Other investigational drugs	30 days or 5 half-lives, whichever is longer
Non-selective beta-blocking agents	7 days
Cardiac antiarrhythmics Class Ia, III	7 days; amiodarone, 3 months
Anticonvulsants for seizure disorder	Allowed if stable dose for 12 months and free of seizures for 1 year
Anticonvulsants for other indications	Allowed if stable dose for at least 3 months and the Investigator confirms there have been no seizures within the past 12 months.
Tricyclic antidepressants	14 days
Monoamine oxidase inhibitors	14 days
Anti-tumor necrosis factor $\alpha$ (TNF $\alpha$ ) antibodies (eg, infliximab and any other members of this class of drugs)	30 days or 5 half-lives, whichever is longer
Monoclonal antibodies	30 days or 5 half-lives, whichever is longer
Antipsychotic drugs <sup>a</sup>	30 days
Systemic calcineurin inhibitors, systemic antifungal agents, protease inhibitors and cimetidine	30 days
Systemic anticholinergics <sup>b</sup>	7 days

d. Antipsychotic agents used for other indications may be allowed after consultation with the Medical Monitor/or designee of the trial.

e. If systemic anticholinergics are used for treatment of overactive bladder and the treatment has been constant for at least 1 month, they are allowed.

**Note:** Benzodiazepines are not exclusionary.

## 5.5 Other Restrictions, Illicit Drugs or Drugs of Abuse

### 5.5.1 Illicit Drugs and/or Drugs of Abuse

Illicit drugs or drugs of abuse will not be allowed from the start of Screening (Visit 1) to the end of Visit 5 or to whenever the subject discontinues the study. If any illicit drugs or drugs of abuse are used by the subject during the study, the dates of use and the amount will be documented, and the subject will be discontinued. Medical marijuana is not an exclusionary drug if used for medical purposes, and there is no change in the dose or frequency of consumption.

### 5.5.2 Dietary Restrictions

Subjects are encouraged to refrain from consuming grapefruits or grapefruit juice throughout the study. Subjects must not ingest xanthine (ie, caffeine)-containing foods and beverages for at least 6 hours prior to each study visit and for the duration of each study visit. Examples of



such products include coffee, tea, chocolate, and cola. Decaffeinated beverages are acceptable.

## 5.6 Smoking Status

Changes in a subject's smoking status (ie, stopping or re-starting smoking) may have an impact on the efficacy outcome measures. At all visits the subject will be asked about any recent change in their smoking status (ie, whether a subject's status has changed from smoker to non-smoker or vice versa). Any change in smoking status during the run-in period (Visit 1 to Visit 2) will result in a screen failure. Smoking status changes during the 2 week TPs will be captured in the eCRF, but the subject will be permitted to continue in the study. Subjects will be required to refrain from smoking (including medical marijuana and electronic cigarettes) for at least 4 hours prior to each study visit and throughout the duration of each study visit. Study participants may utilize various nicotine replacement treatments such as chewing gum and patches (PRN), in accordance with recommendations from the Investigator during the entire study visit.

**Note:** For this study, the use of electronic cigarettes will be treated in the same manner as smoking except for the calculation of pack-years to determine cigarette smoking history.

## 5.7 Reasons and Procedures for Early Termination

Subjects may be withdrawn from the study at any time at their own request, upon request of the Investigator, or by Pearl at any time or for any reason. All subjects who discontinue the study because of AEs will be followed up at suitable intervals in order to evaluate the course of the AE and to ensure the reversibility or stabilization of the abnormality. All subjects who prematurely discontinue the study after being randomized, regardless of the cause, should undergo the assessments outlined in [Section 8.6](#) on the date of discontinuation. If a subject experiences any of the changes of concern listed below, a repeat assessment should be obtained, and, if confirmed, the Investigator or designee needs to make a determination as to the suitability of continuing the subject in the study. The changes of concern include:

- Following dosing, a heart rate increase of greater than 40 bpm from the pre-dose value obtained on Day 1 of Treatment Period 1 (Visit 2) and Treatment Period 2 (Visit 4) and the measured value is also >120 bpm.
- Following dosing, a systolic blood pressure (SBP) increase of more than 40 mmHg from the pre-dose value obtained on Day 1 of Treatment Period 1 (Visit 2) and Treatment Period 2 (Visit 4) and the measured value is also >160 mmHg.
- Decrease in creatinine clearance to a value below 30 ml/minute/1.73m<sup>2</sup> using MDRD equation or a clinically relevant change from baseline as determined by the Investigator.
- Hepatic impairment defined as abnormal liver function test of AST, ALT or total bilirubin  $\geq 3$  times upper limit of normal on repeat testing
- Calculated QTcF intervals >500 millisecond (msec), and have increased by 60 msec or more over baseline value obtained at Day 1 of Treatment Period 1 (Visit 2) and Treatment Period 2 (Visit 4).

- Subjects who suffer a mild exacerbation will remain in the study and continue to take their assigned study drug unless the Investigator decides that it is in the best interest of the subject to discontinue early from the study. Any subject who suffers a moderate or severe exacerbation will be discontinued.

An exacerbation will be defined as a change in the subject's baseline dyspnea, cough, and/or sputum (increase in volume or change in color towards purulence) that lasts 3 or more days, is beyond normal day-to-day variations, is acute in onset and may warrant a change in regular medication. The severity of exacerbations will be classified as follows:

- Mild: exacerbations that do not require systemic steroids or antibiotics, and do not result in hospitalization or death.
- Moderate: exacerbations that requires treatment with systemic steroids and/or antibiotics, and do not result in hospitalization or death.
- Severe: exacerbations that result in hospitalization or death.

If a subject requires the following prohibited medications they should be discontinued from the study:

- Initiation of maintenance therapy with any prohibited medications as listed in [Table 5-4](#).
- Initiation of maintenance therapy with a marketed LABA (eg, salmeterol, formoterol, indacaterol) administered alone or in combination with an ICS or a marketed LAMA (eg, tiotropium, aclidinium, or glycopyrronium bromide [Seebri]).
- Initiation of corticosteroids/antibiotics for the treatment of exacerbation

If a female subject becomes pregnant during the course of the study, the subject will be discontinued and the pregnancy will be followed full-term through delivery or final outcome (refer to [Section 7.3.9](#)).

## **6 LABELING, PACKAGING, STORAGE, DISPENSING, AND RETURN OF CLINICAL SUPPLIES**

### **6.1 Subject Information**

Clinical supplies will be packaged to support enrollment of the study. Clinical supplies will be packaged according to a component schedule generated by a specialized company. The unblinded study pharmacist will assign the study drug to subjects according to a separate randomization schedule and will manage the distribution of clinical supplies. All other study personnel will remain blinded.

### **6.2 Product Descriptions**

Investigational materials will be provided by Pearl as summarized in [Table 6-5](#).

Treatments will be blinded in terms of GFF MDI or Placebo MDI administered; these products are identical in form and function and indistinguishable from each other. Ventolin and Atrovent are open-label products.

**Table 6-5. Study Product Packaging Descriptions**

<b>Product name and dosage</b>	<b>Product strength</b>	<b>Dose form/fill count</b>	<b>Administration</b>
<b>Study medications</b>			
GFF MDI (PT003) 14.4/9.6 µg ex-actuator	GFF MDI 7.2/4.8 µg per actuation	1 MDI 120 inhalations	Taken as two inhalations BID
<b>Open-label products</b>			
Ventolin (albuterol sulfate) HFA inhalation aerosol 90 µg ex-actuator	Ventolin (albuterol sulfate) HFA inhalation aerosol will be the supplied product Each inhalation contains 108 µg corresponding to 90 µg albuterol base per actuation	1 MDI 60 or 200 actuations	Taken PRN
Atrovent (ipratropium bromide) HFA inhalation aerosol 34 µg ex-actuator	Atrovent (ipratropium bromide) HFA will be the supplied product Each inhalation contains 17 µg ex-actuator per actuation	1 MDI 200 actuations	Taken as two inhalations QID during run-in period and washout period
<b>Placebo</b>			
Placebo MDI	Formulation does not contain active ingredient	1 MDI 120 inhalations	Taken as two inhalations BID

Abbreviations: BID=twice daily; COPD=chronic obstructive pulmonary disease; GFF MDI=Glycopyrronium and Formoterol Fumarate Inhalation Aerosol; HFA=Hydrofluoroalkane; MDI=Metered Dose Inhaler; PRN=as needed; QID=four times daily

**Note:** All study drugs will be administered by oral inhalation.

**Note:** Glycopyrronium 14.4 µg in GFF MDI is equivalent to 18 µg of glycopyrronium bromide.

Open-label Atrovent HFA MDIs will be provided from commercial supplies. Manufacturer’s instructions for study drug administration will be provided.

Open-label Ventolin HFA MDIs with dose counters will be provided from commercial supplies. Manufacturer’s instructions for study drug administration will be provided.

### 6.3 Primary Packaging and Labeling Information

Investigational materials will be packaged by Pearl. Atrovent HFA and Ventolin HFA supplies will be supplied as open-label MDIs.

**Blinded Supplies:** Each MDI will be labeled with a single label. The MDI actuator will be labeled with a single label. The foil pouch will be labeled with a single label.

**Open-label Supplies:** Open-label Atrovent HFA and Ventolin HFA will be provided as individually labeled MDIs. Each MDI will contain a single label. The MDI actuator will be labeled with a single label. The foil pouch will be labeled with a single label.

Both single and two-part labels will be printed with black ink and may include the following text:

Packaging Lot Trace ID #	Dosing Instructions
Space for entry of screening #	Storage Conditions
Component ID #	Compound ID - Protocol #
Space for entry of randomization #	Country regulatory requirements
Fill Count & Dosage Form	Sponsor address (If applicable)
Space for entry of Interval ID (Visit # only)	Translation Key (If applicable)
Re-evaluation/Expiration date (if applicable)	

Abbreviation: ID=identification

#### 6.4 Secondary Packaging and Labeling Information (Box)

Blinded investigational drug and open-label (Atrovent HFA and Ventolin HFA) supplies will be packaged in individual boxes as outlined in [Table 6-6](#). Box configuration is subject to change as a result of packaging constraints.

**Table 6-6. Description of Boxes**

Drug supplies	Individual box contents
Blinded	1 MDI
Atrovent HFA	1 MDI
Ventolin HFA	1 MDI

Each box will be labeled with a two-part label printed with black ink and may include the following text:

Packaging Lot ID #	Dosing Instructions (if applicable)
Space for entry of screening #	Storage Conditions
Component ID #	Compound ID - Protocol #
Space for entry of randomization #	Country regulatory requirements
Kit Contents (1 MDI)	Sponsor address (If applicable)
Space for entry of Interval ID	Translation Key (If applicable)
Re-evaluation/Expiration date (if applicable)	

Abbreviation: ID=identification

## 6.5 Emergency Unblinding of Treatment Assignment

The individual subject emergency code break sealed envelopes should be used in order to unblind subjects and to unmask drug identity. When the Investigator needs to unblind a subject, he/she must confirm the necessity to unblind the subject. The Investigator or treating physician may unblind a subject's treatment assignment only in the case of an emergency, when knowledge of the study treatment is essential for the appropriate clinical management or welfare of the subject. Whenever possible, the Investigator must first discuss options with the Sponsor or appropriate study personnel before unblinding the subject's treatment assignment. If this is impractical, the Investigator must notify Pearl as soon as possible, but without revealing the treatment assignment of the unblinded subject, unless that information is important for the safety of subjects currently in the study. The date and reason for the unblinding must be recorded in the appropriate data collection tool.

## 6.6 Storage Requirements

**Blinded supplies:** Store below 25° C (77° F) in a dry place. Excursions permitted up to 30° C (86° F).

**Ventolin HFA supplies:** Store between 15° and 25°C (59° and 77°F). Store the inhaler with the mouthpiece down. For best results, the inhaler should be at room temperature before use. Do not use or store near heat or open flame. Exposure to temperatures above 120 °F (49 °C) may cause bursting. Never throw into a fire or incinerator.

**Atrovent HFA supplies:** Store at 25°C (77°F); excursions permitted to 15°-30°C (59°-86°F). For optimal results, the canister should be at room temperature before use. Do not puncture. Do not use or store near heat or open flame. Exposure to temperatures above 120°F may cause bursting. Never throw the inhaler into a fire or incinerator.

The clinical supplies storage area at the site must be monitored by the site staff for temperature consistency with the acceptable storage temperature range specified in this protocol or in the product label. Documentation of temperature monitoring should be maintained.

## **6.7 Instructions for Preparation of Treatments for Administration and Dispensing**

### **6.7.1 GFF MDI and Placebo MDI**

Individual GFF MDI and Placebo MDI will be packaged in a foil pouch and contained in an individual visit treatment box. Both the visit treatment box and the foil overwrap will have a label with a component identification number. Confirm that the identifier given by the randomization lists and the component identification number written on the label are the same. The visit treatment box is labeled with a two-part label. Write the subject number and treatment visit number on each of the two-part labels. The ‘tear-off’ part of the label is to be placed onto the subjects worksheets.

All MDIs must be primed before the first use. Priming involves releasing a certain number of sprays (4) into the air before the first use of the inhaler. Shaking and priming the inhaler fills a chamber inside the canister with the correct dose and mix of medication so that the inhaler is ready to use.

The MDI must be primed in a separate room from the subject treatment area. Each dose will consist of 2 puffs from the MDI. Subjects will be dispensed the MDI and instructed to continue taking study medication twice daily, 2 puffs in the morning and 2 puffs in the evening approximately 12 hours apart, until subject returns to the clinic. The MDI should be stored upright at room temperature by the subject, avoiding temperature extremes, and storage in direct sunlight. Refer to [Appendix 1](#) for instructions on the administration of GFF MDI and Placebo MDI. Cleaning instructions are provided in [Appendix 1](#).

### **6.7.2 Atrovent HFA (Ipratropium Bromide)**

Open-label Atrovent HFA will be provided by Pearl and stored in a secured location within the clinic or pharmacy facilities.

Atrovent HFA is a solution aerosol that does not require shaking. However, as with any other MDI, some coordination is required between actuating the canister and inhaling the medication. Atrovent HFA should be primed per manufacturer’s instructions prior to dispensing to subject (ie, "prime" or actuate Atrovent HFA before using for the first time by releasing 2 test sprays into the air away from the face). In cases where the inhaler has not been used for more than 3 days, prime the inhaler again by releasing 2 test sprays into the air away from the face. Subjects should avoid spraying Atrovent HFA into their eyes.

Subjects will be dispensed the Atrovent HFA for COPD maintenance therapy during the run-in period (between Visit 1 and 2) and during the washout period (between Visit 3 and 4) per the manufacturer’s instruction, 2 puffs with each administration four times a day, divided over the daytime. The MDI should be stored at room temperature by the subject, avoiding temperature extremes and storage in direct sunlight. Refer to [Appendix 2](#) for the manufacturer’s instructions on the administration of Atrovent HFA.

### 6.7.3 Ventolin HFA (Albuterol Sulfate)

Open-label Ventolin HFA will be provided by Pearl and stored in a secured location within the clinic or pharmacy facilities. Ventolin HFA should be stored at room temperature by the subject. Ventolin HFA should be primed per manufacturer's instructions prior to dispensing to subject. Refer to [Appendix 3](#) for the manufacturer's instructions on the administration of Ventolin HFA. Study personnel will record number on the dose counter at the time of dispensing (following priming and characterization of reversibility) and upon return.

## 6.8 Drug Accountability/Return of Clinical Supplies

**Under no circumstances will the Investigator(s) allow the study drug to be used other than as directed by this protocol.**

Investigational clinical supplies must be received by a designated person at the study site, handled and stored safely and properly, and kept in a secure location to which only the Investigator and designated assistants have access. Storage conditions for the clinical supplies should be observed, monitored and documented. Clinical supplies are to be dispensed only in accordance with the protocol. The Investigator is responsible for keeping accurate records of the clinical supplies received from Pearl, the amount dispensed to and returned by the subject, and the amount remaining at the conclusion of the study. The Clinical Monitor should be contacted with any questions concerning investigational products where special or protective handling is indicated. At the end of the study, all clinical supplies including partial and empty containers must be returned as directed by Pearl.

Sites should check with the Pearl representative for appropriate documentation that needs to be completed for drug accountability.

The Investigator or designated assistant should not open individual clinical supply containers until all pre-dose assessments have been completed and the subject is eligible to be randomized/continue with the study. Any deviation from this must be discussed with the Clinical Monitor.

For each subject, all used study drug materials will be collected. Used subject supplies will be kept at room temperature in a secure and locked cabinet until returned to Pearl or designee.

**Note:** Used study drug will be stored separately from unused study drug.

All product complaints (including device malfunctions) must be reported to Pearl using the Product Complaints Form provided in each site's investigator file. Pearl will contact the site to evaluate the nature of the complaint and determine what further action is needed.



## 7 STUDY PROCEDURES

The ICF must be obtained *prior* to performing any and all study-related activities. The ICF must be approved by the Independent Ethics Committee (IEC)/ Institutional Review Board (IRB) that is reviewing the study documents. Informed consent will be obtained for all subjects participating in the study. Subjects may withdraw consent at any time. Participation in the study may be terminated at any time without the subject's consent as determined by the Principal Investigator.

A schedule of events is provided in [Table 8-](#). Detailed schedules for pre- and post-dose procedures to be performed on visit days are provided in [Table 8-10](#) and [Table 8-11](#).

### 7.1 Efficacy Assessments

#### 7.1.1 HRCT scans

A HRCT scan as baseline measurement will be taken on Day 1 of each TP (Visit 2 and Visit 4). The pre-dose CT-scan of the thorax will be taken on two breathing levels, TLC and FRC. During Visit 2 an additional scan of the UA will be taken. The post-dose measurement will only be performed on one breathing level, TLC. The Post dose TLC scan will be taken after approximately 2 weeks of treatment with either GFF MDI or Placebo on Day 15 ( $\pm$  5 days) (Visit 3 and Visit 5).

On Day 1 of each TP (Visit 2 and Visit 4) the CT scans will be taken at least 30 minutes prior to dosing.

Post dose HRCT scan on Day 15 ( $\pm$  5 days) of each TP (Visit 3 and Visit 5) should be started 90min  $\pm$  30 minutes after dosing (approximately between 1pm-2pm). Spirometry followed by body plethysmography will be performed after the HRCT scans but within 150 minutes after dosing.

Between the two TPs there will be a washout period of a minimum of 5 days to a maximum of 21 days.

Whenever possible the same scanner should be used at all the study visits.

HRCT scan is performed with a low radiation protocol. These images are made to perform Computational fluid dynamics (CFD) in order to obtain more information on regional lung function characteristics. For more details of the protocol of CT scan and CFD please refer to the addendum in [Appendix 7](#).

## 7.1.2 Spirometry

Forced expiratory spirometry maneuvers for derivation of FEV<sub>1</sub>, FVC, FEF<sub>25-75</sub>, FEV<sub>1</sub>/FVC ratio and IC will be assessed using a spirometer that meets or exceeds minimum performance recommendations of the ATS.

Spirometry will be conducted at all visits. At Visit 1, Spirometry will be conducted approximately 60 minutes and 30 minutes prior to bronchodilator administration and approximately 30-60 minutes post-bronchodilator (refer to [Section 7.1.2.1](#)).

**Note:** Spirometry must meet the severity and both acceptability and repeatability criteria (refer to [Section 5.1](#) and [Section 5.2](#)).

At Visit 2 and Visit 4, spirometry will be obtained at the beginning of the visit. A second spirometry will be obtained before the study drug administration after the pre-dose CT-scans are taken. The -60 minute FEV<sub>1</sub> value obtained at Visit 4 prior to study drug administration will be used to check the stability criteria. At Visit 3 and Visit 5, spirometry will be obtained before the study drug administration, and post-dosing of study drug. Post-dose spirometry assessments will not be conducted before the CT-scan is taken. At Visits 3 and 5 none of the post dose assessments will start before 1 hour after the administration of the study drug. All assessments should be completed within 2.5 hours after dosing.

### 7.1.2.1 Characterization of Reversibility

Reversibility to Ventolin HFA (SABA) will be evaluated at Visit 1.

The procedure will be, as follows:

Reversibility testing to Ventolin HFA:

- Perform pre-bronchodilator PFTs (approximately -60 minutes and -30 minutes) prior to administration of Ventolin HFA (albuterol).
- Administer 4 puffs of Ventolin HFA (albuterol).
- Perform post-bronchodilator PFT 30-60 minutes after the administration of Ventolin HFA.

Reversibility will be a comparison of the average best FEV<sub>1</sub> effort obtained at approximately -60 minutes and -30 minutes pre-bronchodilator to the best FEV<sub>1</sub> effort obtained at approximately 30-60 minutes post-bronchodilator. A subject is determined to be reversible to Ventolin HFA if the improvement in FEV<sub>1</sub> approximately 30-60 minutes following administration of 4 puffs of Ventolin HFA, respectively, is  $\geq 12\%$  and  $\geq 200$  ml. Reversibility to Ventolin HFA (obtained at Visit 1) will be used to characterize the population.

### 7.1.2.2 Stability Criteria

It is important to ensure that the baseline FEV<sub>1</sub> is stable and reflective of the subject's COPD severity prior to continuation in the second treatment period.

At Visit 2, spirometry will be obtained at the beginning of the visit. A second spirometry will be obtained before the study drug administration after the pre-dose CT scans are taken. The average of the FEV<sub>1</sub> values obtained prior to study drug administration (- 60 min and - 30 min) at Visit 2 will be the baseline value used to compare with the -60 minute FEV<sub>1</sub> value obtained at Visit 4.

At Visit 4, if the pre-dose FEV<sub>1</sub> is outside of the  $\pm 20\%$  or 200 mL range the visit may be rescheduled at the Investigator's discretion, or the subject may be discontinued.

### 7.1.2.3 Inspiratory Capacity

**Visit 1 to Visit 5:** IC assessments will be conducted with every spirometry. All subjects will be instructed on the performance of the IC maneuver. Subjects must be tested in the seated position wearing a nose clip with no air leaks between the mouth and mouthpiece. Subjects should be relaxed with shoulders down and asked to breathe regularly for several breaths until the end-expiratory lung volume is stable (this usually requires at least five tidal maneuvers). They are then urged to take a deep breath to TLC with no hesitation. From at least three acceptable trials, the two largest IC measurements should agree within 5% or 150 ml, both of these IC values will be captured and analyzed.

### 7.1.2.4 Standardization of IC and Spirometry Collections

All pulmonary function tests including FEV<sub>1</sub>, FVC, FEF<sub>25-75</sub>, FEV<sub>1</sub>/FVC ratio, as well as all IC assessments, as defined in ATS/ERS guidelines will be performed in accordance with ATS criteria (Miller, 2005).

The volume accuracy of the spirometer is to be checked daily using a 3 L syringe across 3 flow ranges (ie, low, medium and high flows), with temperature and barometric pressure correction. The calibration syringe must meet ATS specifications and must not be used beyond the expiry date. Required accuracy is  $\pm 3\%$  (i.e, 3,09 L to 2,91 L) (ATS/ERS). The results of the calibration factor will be maintained on site, which will be available if the sponsor wants to check for compliance or an audit.

## 7.1.3 Body plethysmography

**Visit 2 to Visit 5:** RV, TLC, FRC, R<sub>aw</sub>, sR<sub>aw</sub>, sG<sub>aw</sub> will be measured using body plethysmography.

On Day 1 of each TP (Visit 2 and Visit 4) the body plethysmography measurement will be performed after the CT-scan before the IP administration.

On Day 15 ( $\pm 5$  days) of each TP (Visit 3 and Visit 5) the body plethysmography measurement will be performed after the CT-scan and after the post-dose spirometry measurement.

Post dose activities on Day 15 ( $\pm$  5 days) of each TP (Visit 3 and Visit 5) will be started 1 hour after dosing on and will be concluded within 2.5 hours after dosing.

#### **7.1.4 Diffusion capacity**

The single-breath diffusing capacity of the lungs for carbon monoxide (TCO), alveolar volume (VA) and TCO/VA will be measured at Visit 1. TCO measurement will be used to characterize the subjects enrolled in the trial and will not be used to determine subject eligibility to participate in the study.

#### **7.1.5 Inhalation Profile with Body Plethysmography**

**Visit 2 and Visit 4:** In order to draw an airflow versus time curve, the subject's inhalation profile will be measured. The subject will be asked to inhale and exhale maximally through a mouthpiece without a nose clip. This measurement is performed with a body plethysmograph. At the moment of this measurement the signal from the respiration belt, used for the measurement of the inhalation profile during the study drug administration, will also be logged.

#### **7.1.6 Inhalation Profile during administration**

**Visit 2 and Visit 4:** During IP administration on Day 1 of both active and placebo, the inhalation profile will be recorded while the subject inhales through the device to generate a subject specific inhalation profile by using a respiration belt. The thorax and abdomen expansion will be measured with the [REDACTED] diagnostic device. This inhalation profile which represents the lung expansion during inhalation of the medication can be coupled with the values of the corresponding lung volume expansion (RV – TLC) measured with the body plethysmography wearing the respiration belts.

Sensor cables transmit the appropriate signals to the [REDACTED]. The signals are stored on the removable memory card, or if configured to do so, the signals can be displayed from the [REDACTED] on a computer running the [REDACTED] software application.

#### **7.1.7 Subject Diary Data Collection**

At Visit 1, subjects will be provided with a Diary to be completed twice daily (morning and evening). Study personnel will train subjects on Diary completion and will instruct subjects to return Diary responses to the clinic for all in-clinic study visits.

- At Visit 1, subjects will be instructed to record in the Diary Atrovent HFA four time daily use and rescue Ventolin HFA use during the Run-in Period prior to Visit 2.
- At Visit 2, subjects will be instructed to record in the Diary study medication administration and the use of rescue Ventolin HFA.
- At Visit 3, subjects will be instructed to record in the Diary Atrovent HFA four time daily use and rescue Ventolin HFA use during the Wash-out Period between Visit 3 and Visit 4.

- At Visit 4, subjects will be instructed to record in the Diary study medication administration and the use of rescue Ventolin HFA.

Diary Compliance Requirement: Subject participation may be terminated at any time during the study for the following reason:

Chronic failure, in the judgment of the Investigator, to comply with diary completion, despite documentation at the site of repeated efforts to reinforce compliance. As defined for this study, compliance requires >70% subject completion of diary assessments. The Sponsor may also instruct a site to discontinue a subject based on consistent noncompliance.

Subjects who are unable to meet the compliance requirement (>70% subject completion of diary assessments) in the last 7 days preceding the Randomization Visit (Visit 2) must be retrained. When retraining is required due to noncompliance the Randomization Visit (Visit 2) must be rescheduled.

In-clinic dosing times and dose indicator readings will be documented in the eCRF by the site staff and will not be entered by the subject into their Diary.

During the treatment periods, each subject will record his/her symptoms in the study-provided Diary, twice daily (morning and evening). The subject will record his/her use of rescue Ventolin HFA twice daily, morning and evening. In addition, the subject will record study medication usage.

#### **7.1.8 Rescue Ventolin HFA Use**

Subjects requiring more than 8 puffs per day on 3 consecutive days with worsening symptoms should contact the site. The number of “puffs” of rescue Ventolin HFA is the number of actuations of the canister. For example, when rescue Ventolin HFA is required and 2 actuations are inhaled, this should be counted as 2 “puffs.” In the event the subject requires 4 actuations, this should be counted as 4 “puffs”.

At Visit 2 to 5 the subject will be asked to bring the rescue Ventolin HFA and the site personnel will record the number of actuations of the canister.

#### **7.1.9 Recording of Dose Indicator Reading**

The GFF MDI and Placebo MDI are fitted with a dose indicator to track use of the MDI.

Site personnel will be instructed to record the dose indicator reading from the MDI after priming (prior to the first dosing Day 1) and after the first dosing Day 1 of both the TPs (Visit 2 and Visit 4). All MDIs must be primed before the first use. Priming involves releasing a certain number of sprays (4) into the air before the first use of the inhaler. Shaking and priming the inhaler fills a chamber inside the canister with the correct dose and mix of medication so that the inhaler is ready to use (For more details refer to [Section 6.7](#)).

Prior to dosing at Day 15 ( $\pm$  5 days) of each TP Visit (Visit 3 and Visit 5) or at a Premature Discontinuation Visit, site personnel will observe the dose indicator reading on the study drug returned by the subject and record the dose indicator reading in the source.

**Note:** The dose indicator reading recorded by the site staff on Day 15 ( $\pm$  5 days) of each TP (Visit 3 and Visit 5) will be the dose indicator reading observed prior to subject dosing.

At each visit, the site staff will compare the dose indicator reading from the prior entered reading of Day 1 of that TP. For major discrepancies (ie, >20 puff difference), the site staff will review the major discrepancy with the subject and document reason for the major discrepancy in the appropriate study source and eCRF. If appropriate, site staff will retrain the subject on the proper use of the MDI.

### **7.1.10 Subject Questionnaires**

The following subject questionnaires will be completed by subjects using the study supplied questionnaire at Visit 1: CAT, and MMRC.

#### **7.1.10.1 COPD Assessment Test**

The CAT is a self-administered questionnaire designed to assess the condition of subjects and overall impact of COPD. Since the CAT is designed to assess the impact of COPD on the subject by measuring overall impairment, it has moderate correlations with other instruments, such as the MMRC Dyspnea Scale.

Subjects will complete the CAT (refer to [Appendix 4](#)) at Visit 1.

The CAT score will describe the burden and symptomatic impact of COPD in subjects enrolled in the trial and will not be used to determine subject eligibility to participate in the study.

#### **7.1.10.2 Modified Medical Research Council Dyspnea Scale**

The MMRC Dyspnea Scale uses a simple grading system to assess a subject's level of dyspnea, shortness of breath ([Table 7-7](#) and [Appendix 5](#)).

**Table 7-7: MMRC Dyspnea Scale**

<b>Grade</b>	<b>Description of Breathlessness</b>
0	I only get breathless with strenuous exercise.
1	I get short of breath when hurrying on level ground or walking up a slight hill.
2	On level ground, I walk slower than people of the same age because of breathlessness, or have to stop for breath when walking at my own pace.
3	I stop for breath after walking about 100 meters or after a few minutes on level ground.
4	I am too breathless to leave the house or I am breathless when dressing.

The MMRC scale is a five-point scale published in 1959 that considers certain activities, such as walking or climbing stairs, which provoke breathlessness (Fletcher 1959). In one minute, the subject selects a grade on the MMRC scale that most closely matches his/her severity of dyspnea. The MMRC scale is considered a discriminative instrument that can categorize subjects with COPD in terms of their disability. The MMRC scale is not satisfactory as an evaluative instrument to measure changes in dyspnea, and its broad grades are generally unresponsive to interventions such as pharmacotherapy.

Subjects will complete the MMRC scale at Visit 1, as a description of the symptomatic burden in study subjects. The MMRC scale will not be used to determine subject eligibility to participate in the study.

#### **7.1.11 COPD Exacerbations**

Site personnel will evaluate whether the subject has experienced a worsening of their COPD that meets the definition of a COPD exacerbation since their last visit. An exacerbation will be defined as a change in the subject's baseline dyspnea, cough, and/or sputum (increase in volume or change in color towards purulence) that lasts 3 or more days, is beyond normal day-to-day variations, is acute in onset and may warrant a change in regular medication.

All COPD exacerbations will be reported as AEs unless considered a serious adverse event (SAE).

The severity of COPD exacerbations will be classified as follows:

- Mild: exacerbations that do not require systemic steroids or antibiotics, and do not result in hospitalization or death.
- Moderate: exacerbations that require treatment with systemic steroids and/or antibiotics, and do not result in hospitalization or death.
- Severe: exacerbations that result in hospitalization or death.



## 7.2 Safety Assessments

The safety assessments include physical examination findings, vital signs, ECGs, clinical laboratory tests in addition to recording of AEs and SAEs.

### 7.2.1 Medical/Surgical History and Physical Examination

Medical history, including smoking history details, will be collected at Visit 1 (Screening) and updated during the run-in period (Visit 1 to Visit 2). The number of COPD exacerbations requiring oral steroids and/or oral antibiotics, or hospitalization within 12 months of Visit 1 (Screening) will be collected. A complete physical examination will be performed at Visit 1 (Screening) and at Visit 5. A complete physical examination will include evaluation of relevant body parts, general appearance, skin, head, eyes, ears, nose, throat, neck (including thyroid), lymph nodes, chest, heart, abdomen, extremities, and nervous system. Weight, assessed in ordinary indoor clothing with shoes removed and height will be recorded at Visit 1 (Screening).

At all visits (including the follow-up telephone call [TC]) the subject will be asked about any recent change in their smoking status (ie, whether a subject's status has changed from smoker to non-smoker or vice versa).

### 7.2.2 Vital Sign Measurements

Heart rate, systolic and diastolic blood pressure, and temperature ('vital signs') will be assessed as outlined below; assessments may be obtained in either the supine or seated position obtained after the subject has been in the supine position for 5 minutes.

If, in the opinion of the Investigator, a clinically significant vital sign change occurs, then the measurement will be repeated at medically appropriate intervals until the value returns to within an acceptable range. Temperature will be collected at Screening (Visit 1) and at pre-dose at all visits and will not be repeated post-dose.

Obtain heart rate and SBP/Diastolic blood pressure (DBP), as directed below:

- **At Screening (Visit 1):** Baseline measures will be obtained.
- **At Day 1 of each TP (Visits 2 and 4):** *Prior* to study drug administration and *after* study drug administration.
- **At Day 15 (± 5 days) of each TP (Visits 3 and 5):** *Prior* to study drug administration and *after* study drug administration.

**Note:** Any clinically relevant findings from vital sign measurements will be reported as adverse events.



### 7.2.3 12-Lead Electrocardiogram

Twelve-lead ECGs will be performed as described below:

Twelve-lead ECGs will be obtained during Screening (Visit 1), at Day 1 of each TP (Visit 2 (Randomization) and Visit 4), and at Day 15 ( $\pm$  5 days) of each TP, (Visits 3 and 5), as follows:

- **At Visit 1 (Screening):** Each subject will undergo a 12-lead ECG
- **At Visit 2 (Randomization) and Visit 4:** Each subject will undergo a 12-lead ECG obtained approximately 60 min *prior* to study drug administration and approximately 90 min *after* study drug administration.
- **At Visits 3 and 5 (Day 15  $\pm$  5 days of each TP):** Each subject will undergo a 12-lead ECG approximately 60 min *prior* to study drug administration and approximately 90 min *after* study drug administration.

**Note:** Baseline ECG values are defined as the last value obtained prior to dosing on Day 1 of Treatment Period 1 (Visit 2) and Treatment Period 2 (Visit 4). Electrocardiogram parameter assessments include: heart rate, PR interval, QRS duration, QT interval, and QTcF.

**Note:** The study team is encouraged to maintain study timepoints.

**Note:** Any clinically relevant findings from ECGs will be reported as adverse events.

ECG values will be checked by the investigator or designee.

QT intervals and calculated QTcF intervals will be reviewed and checked for gross inaccuracies by the Investigator or designated ECG reviewer. If the calculated QTcF intervals are  $>500$  msec, and have increased by  $\geq 60$  msec over the baseline value obtained on Day 1 of Treatment Period 1 (Visit 2) and Treatment Period 2 (Visit 4), the Investigator will make a determination on the suitability of continuing the subject in the study. Refer to [Section 5.7](#) for specific criteria for QTcF that prompt subjects to be discontinued from the study. If QTcF interval prolongation exceeding these limits is verified during treatment, the subject's medical background should be examined closely for risk factors that may have contributed to the event, including genotyping for hereditary long QT syndromes, if appropriate.

Every clinical significant deviation after the subject is randomized in this study must be recorded as an AE and reported to the Sponsor.

The decision to continue the treatment of any subject with prolonged QT or QTcF interval must be discussed and agreed upon by the Investigator and the Sponsor. All such subjects, including subjects with cardiac arrhythmias, should be monitored closely. If appropriate, ECG monitoring should be performed until the QT and QTcF interval and waveform morphology have returned to normal. If the prolongation or abnormal rhythm persists, the Sponsor must be contacted.

## 7.2.4 Clinical Laboratory Tests

Clinical safety laboratory tests will be analyzed by local laboratory according to standardized, validated assays. The laboratory will supply detailed instructions and all containers for blood and urine investigations. Blood sample volumes will meet the laboratory's specification. All clinical laboratory tests will be obtained at Visit 1 (Screening) and prior to dosing at Visit 2 (Day 1 of TP 1), Visit 3 (Day 15 ± 5 days of TP 1), Visit 4 (Day 1 of TP 2) and Visit 5 (Day 15 ± 5 days of TP 2) or Premature Discontinuation Visit.

### 7.2.4.1 Hematology

Hemoglobin, Mean corpuscular hemoglobin (MCH), Mean corpuscular hemoglobin concentration (MCHC), Mean corpuscular volume (MCV), hematocrit, red blood cell count, white blood cell count with differential, and platelet count will be measured at Visit 1 (Screening) and prior to dosing at Visit 2 (Day 1 of TP 1), Visit 3 (Day 15 ± 5 of TP 1), Visit 4 (Day 1 of TP 2) and Visit 5 (Day 15 ± 5 of TP 2) or Premature Discontinuation Visit.

**Note:** Any clinically relevant findings from Hematology will be reported as adverse events.

### 7.2.4.2 Clinical Chemistry

Albumin, alkaline phosphatase, total bilirubin, calcium, total cholesterol, magnesium, phosphate, sodium, potassium, chloride, creatinine, Gamma-glut amyl transferase ( $\gamma$ -GT), bicarbonate, triglycerides, blood glucose, total protein, blood urea nitrogen (BUN), AST and ALT will be measured at Visit 1 (Screening) and prior to dosing at Visit 2 (Day 1 of TP 1), Visit 3 (Day 15 ± 5 of TP 1), Visit 4 (Day 1 of TP 2) and Visit 5 (Day 15 ± 5 of TP 2) or Premature Discontinuation Visit.

The Laboratory will supply material for the collection of these samples (refer to [Table 7-8](#) for an overview of the lab parameters for the blood investigations).

**Note:** Any clinically relevant findings from clinical chemistry tests will be reported as adverse events.

**Table 7-8: Lab Parameters**

<b>Hematology</b>	
Hemoglobin	MCH
Hematocrit	MCHC
White Blood Cell count with differential	MCV
Red Blood Cell count	
Platelet Count	
<b>Clinical Blood Chemistry</b>	
<b>Liver Enzyme and Other Function Tests</b>	<b>Other Clinical Blood Chemistry</b>
ALT	Albumin
AST	Calcium
Alkaline phosphatase	Chloride
Bilirubin, total	Cholesterol
γ-GT	Bicarbonate
	Creatinine
	Glucose
	Magnesium
	Potassium
	Phosphate
	Protein, total
	Sodium
	Triglycerides
	BUN

**Other Tests:**

Creatinine clearance will be estimated by the  $GFR_{MDRD}$  formula.

**7.2.4.3 Urinalysis**

Urine dipstick: red blood cell count, nitrite, white blood cell count, pH, bilirubin, protein, ketones, glucose, density.

Microscopic analysis will only be performed if dipstick is positive.

Urinalysis will be measured at Visit 1 (Screening) and prior to dosing at Visit 2 (Day 1 of TP 1), Visit 3 (Day 15 ± 5 of TP 1), Visit 4 (Day 1 of TP 2) and Visit 5 (Day 15 ± 5 of TP 2) or Premature Discontinuation Visit.

#### **7.2.4.4 Pregnancy Test**

A urine pregnancy test will be performed in women of childbearing potential only at Visit 1 (Screening) and prior to dosing at Visit 2 (Day 1 of TP 1), Visit 3 (Day 15 ± 5 of TP 1), Visit 4 (Day 1 of TP 2) and Visit 5 (Day 15 ± 5 of TP 2) or Premature Discontinuation Visit.

If any of these tests are positive, the subject must be discontinued from the study. The pregnancy test should be performed at the beginning of the visit.

### **7.3 Adverse Events**

#### **7.3.1 Performing Adverse Events Assessments**

The Investigator is responsible for promptly documenting and reporting all AEs observed during the study in the subject's case report form. If the AE is "alarming," the Investigator must report the AE immediately to Pearl. In addition, certain AEs (as described in [Section 7.3.7](#)) are classified as "serious" and must be reported no later than 24 hours after the Investigator recognizes/classifies the event as a SAE to Pearl or its designee.

In the case of SAEs, after discussing the details of the AE, the Investigator and the Sponsor may discontinue the subject prematurely.

#### **7.3.2 Adverse Event Definitions**

The following definitions of terms are guided by the International Conference on Harmonization (ICH), the U.S. Code of Federal Regulations [21 Code of Federal Regulations (CFR) 312.32] and EU Directive 2001/83/EC and are included herein.

An AE is any untoward medical occurrence associated with the use of a drug in humans, whether or not considered drug related. An AE (also referred to as an adverse experience) can be any unfavorable and unintended sign (eg, an abnormal laboratory finding), symptom, or disease temporally associated with the use of a drug, without any judgment about causality. An AE can arise from any use of the drug (eg, off-label use, use in combination with another drug) and from any route of administration, formulation, or dose, including an overdose.

Adverse events include, but are not limited to:

- Any symptom or condition not previously reported by the subject (medical history).
- An exacerbation of a pre-existing symptom or condition.
- A significant increase in frequency or intensity of a pre-existing episodic event or condition.
- A drug interaction.

- A condition first detected or diagnosed after study drug administration even though it may have been present prior to the start of the study.

An AE does **not** include:

- Medical or surgical procedures (e.g., surgery, endoscopy, tooth extraction, blood transfusion); the condition that results in the procedure is considered an AE (eg, bleeding esophageal varices, dental caries).
- Overdose of either study drug or concurrent medication without any clinical signs or symptoms.
- Non-clinically significant abnormal laboratory values. (If accompanied by signs/symptoms, the signs or symptoms are considered an AE).

### 7.3.3 Pre-Randomization Adverse Events

AEs that occur between the time subject signs the ICF for the study and the time when that subject is randomized will be summarized as medical history and not as a Treatment Emergent AE (TEAE) unless the event meets the definition of a SAE as defined in [Section 7.3.7](#).

### 7.3.4 Severity

The Investigator must categorize the severity of each AE according to the following guidelines:

Mild: Associated with no limitation of usual activities or only slight discomfort; generally not requiring alteration or cessation of study drug administration; and/or not needing therapeutic intervention.

Moderate: Associated with limitation of usual activities or significant discomfort; generally requiring alteration or cessation of study drug administration; and/or requiring therapeutic intervention.

Severe: Associated with inability of subject to carry out usual activities or very marked discomfort; considered to be life-threatening; resulting in significant disability or incapacity; and requiring therapeutic intervention.

### 7.3.5 Relationship

The relationship of each AE to the study drug administration will be assessed by the Investigator after careful consideration, and according to the following guidelines:

Definitely: A reaction that follows a reasonable temporal sequence from administration of study drug; that follows a known or expected response pattern to the study drug; it disappears or decreases on cessation or reduction in study drug dose; and/or it reappears or worsens when the study drug is administered.

Probably: A reaction that follows a reasonable temporal sequence from administration of study drug; that follows a known or expected response pattern to the study drug; and/or that could not be reasonably explained by other factors such as underlying disease, complications, concomitant drugs, or concurrent treatments.

Possibly: A reaction that follows a reasonable temporal sequence from administration of study drug; that follows a known or expected response pattern to the study drug, but that could reasonably have been produced by a number of other factors including underlying disease, complications, concomitant drugs, or concurrent treatments.

Not Related: A reaction for which sufficient data exist to indicate that the etiology is unrelated to the study drug.

### 7.3.6 Clinical Laboratory Adverse Events

Many laboratory abnormalities observed during the course of a study will be included under a reported AE describing a clinical syndrome (eg, elevated BUN and creatinine in the setting of an AE of renal failure, or decreased hemoglobin in a case of bleeding esophageal varices). In such cases, the laboratory abnormality itself (eg, elevated creatinine in a setting of renal failure) does not need to be recorded as an AE. However, isolated laboratory abnormalities should be reported as AEs if they are considered to be clinically significant by the Investigator.

Criteria for a "clinically significant" laboratory abnormality are:

- A laboratory abnormality that leads to a dose-limiting toxicity (eg, an abnormality that results in study drug dose reduction, suspension, or discontinuation)
- A laboratory abnormality that results in any therapeutic intervention (ie, concomitant medication or therapy)
- Other laboratory abnormality judged by the Investigator to be of any particular clinical concern (eg, significant fall in hemoglobin not requiring transfusion)

For laboratory abnormalities that do not meet the above criteria but are outside of normal range (eg, < or > normal reference range), the Investigator should indicate whether the value is clinically significant or not clinically significant for the subject.

### 7.3.7 Serious Adverse Events

An AE is considered "serious" if, in the view of the Investigator or Sponsor, it results in any of the following outcomes:

- Death
- A life-threatening AE
- In subject hospitalization or prolongation of existing hospitalization

- A persistent or significant incapacity or substantial disruption of the ability to conduct normal life functions
- A congenital anomaly/birth defect

Important medical events that may not result in death, be life threatening, or require hospitalization may be considered serious when, based upon appropriate judgment, they may jeopardize the subject and may require medical or surgical intervention to prevent one of the outcomes listed in the definition. Examples of such medical events include allergic bronchospasm requiring intensive treatment in an emergency room (ER) or at home, blood dyscrasias or convulsions that do not result in subject hospitalization, or the development of drug dependency or drug abuse.

Hospitalization for a pre-existing condition, including elective procedures, which has not worsened, does not constitute a SAE.

An AE is considered “life-threatening” if, in the view of the Investigator or Sponsor, its occurrence places the subject or subject at immediate risk of death. It does not include an adverse reaction or suspected adverse reaction that, had it occurred in a more severe form, might have caused death.

An unexpected AE means any AE for which the specificity or severity is not consistent with the current IB.

#### **7.3.7.1 Reporting Serious Adverse Events**

In agreeing to the provisions of this protocol, the Investigator accepts all legal responsibilities for AE identification, documentation, grading, assignment of causality, and prompt notification of SAEs to Pearl Pharmacovigilance or designee. All SAEs must be reported to Pearl Pharmacovigilance or designee no later than 24 hours after the Investigator recognizes/classifies the event as a SAE. At a minimum, a description of the event and the Investigator’s judgment of causality must be provided at the time of the initial report using the appropriate form (eg, SAE Report Form). After the initial report, as necessary, the Investigator must provide any additional information on a SAE to Pearl Pharmacovigilance or designee within 2 working days after he/she receives additional follow-up information this follow-up information will be a detailed written report that may include copies of hospital records, case reports, and autopsy reports, and other pertinent documents.

Post-study SAEs following the last dose of study drug must be reported to Pearl as described in [Section 7.3](#).

The Investigator is responsible for continuing to report any new or relevant follow-up information that he/she learns about the SAE.



### **7.3.7.2 Supplemental Investigations of SAEs**

The Investigator and supporting personnel responsible for subject care should discuss with the Medical Monitor any need for supplemental investigations of SAEs. The results of these additional assessments conducted must be reported to Pearl. If a subject dies during participation in the study and a post-mortem examination is performed, a copy of the autopsy report must be submitted to Pearl Pharmacovigilance.

### **7.3.7.3 Post-Study Follow-Up of Adverse Events**

Any AEs that are unresolved at the subject's last AE assessment in the study are followed up by the Investigator for as long as medically indicated, but without further recording in the eCRF. Pearl retains the right to request additional information for any subject with ongoing AE(s)/SAE(s) at the end of the study, if judged necessary.

### **7.3.7.4 Notification of Post-Study Serious Adverse Events**

The follow up telephone call will be performed 7 – 10 days after Visit 5 so post-study SAEs occurring up to 10 days following the last dose of study drug must be reported to Pearl, whether or not the event is attributable to study drug. All SAEs must be reported to Pearl no later than 24 hours after the Investigator recognizes/classifies the event as a SAE.

### **7.3.7.5 IRB/IEC Notification of Serious Adverse Events**

The Investigator is responsible for notifying her/his IRB/IEC of all SAEs, including any follow-up information, occurring at her/his site and any SAE regulatory report, including any follow-up reports that he/she receives from Pearl. Documentation of the submission to the IRB/IEC must be retained for each safety report. The Investigator is also responsible for notifying Pearl if their IRB/IEC requires revisions to the informed consent form or other measures based on its review of a SAE report.

### **7.3.7.6 Health Authority Safety Reports**

Pearl or its representatives will submit a safety report to the Food and Drug Administration (FDA) and/or any other appropriate regulatory agencies, for any suspected adverse reaction that is both serious and unexpected within the appropriate time frame.

Pearl or its representatives will send copies of each safety report submitted to the FDA and/or other regulatory agencies to the Investigators who are actively participating in Pearl-sponsored clinical studies. Safety reports must be submitted to the appropriate IRB/IEC as soon as possible as described in [Section 7.3.7.5](#)

## **7.3.8 Overdose**

An overdose is defined as a dose greater than the high dose level evaluated in this study as described in [Section 6.2](#) (Product Descriptions) that results in clinical signs and symptoms. In the event of an overdose of study medication, the Investigator should use clinical judgment in treating the overdose and contact the study Medical Monitor. The Investigator



should refer to the relevant document(s) for detailed information regarding warnings, precautions, contraindications, AEs, and other significant data pertaining to the study drug(s) being used in this study. Such document may include, but not be limited to, the IB.

### **7.3.9 Pregnancy**

To ensure subject safety, each pregnancy in a female subject from Visit 1 (Screening) until study completion must be reported to Pearl within 24 hours of learning of its occurrence. The pregnancy should be followed up to determine outcome, including spontaneous or voluntary termination, details of the birth, and the presence or absence of any birth defects, congenital abnormalities, or maternal and/or newborn complications. Pregnancy should be recorded on a Paper Pregnancy Report Form and reported by the Investigator to Pearl Pharmacovigilance or designee. Pregnancy follow-up including pregnancy outcome should be recorded on the same form and should include an assessment of the possible relationship to the Pearl Therapeutics study drug. Any SAE experienced during pregnancy must be reported on the SAE Report Form.

## **7.4 Termination of the Study**

An Investigator may choose to discontinue study participation at any time with sufficient notice by the Investigator for any reason as per the terms of the contract with Pearl.

Pearl reserves the right to discontinue the study at any time for clinical or administrative reasons. Such a termination must be implemented by the Investigator, if instructed to do so by Pearl, in a time frame that is compatible with the subjects' well-being.

## **8 STUDY ACTIVITIES**

A time and events schedule for the study is presented in [Table 8-9](#), [Table 8-10](#) and [Table 8-11](#) present details about activities conducted pre and post dose at Visits 2 through 5.

**Table 8-9: Schedule of Events**

Clinical Variable	Screening	Treatment Period 1		Treatment Period 2		Follow-up
		Visit 2 <sup>n</sup> Day 1	Visit 3 <sup>n</sup> Day 15	Visit 4 <sup>n</sup> Day 1	Visit 5 <sup>n</sup> Day 15	
Study Day	-7 up to -21 <sup>a</sup>	Day 1 <sup>a</sup>	Day 15 ±5 Days	Day 1	Day 15 ±5 Days	7 to 10 days
Informed Consent	X					
Review of Inclusion/Exclusion Criteria	X	X		X		
Diary Training	X					
Review of Diary		X <sup>u</sup>	X	X	X	
Chest X-ray <sup>h</sup>	X					
Reversibility	X					
Demographics and Medical/Surgical History	X <sup>s</sup>					
COPD Assessment Test (CAT)	X					
MMRC	X					
Smoking Status	X	X	X	X	X	X
Prior/Concomitant Medications <sup>b</sup>	X <sup>r</sup>	X	X	X	X	X
Diffusion Capacity	X					
Spirometry <sup>c</sup>	X	X	X	X	X	
Body Plethysmography		X	X	X	X	
Physical Examination <sup>d</sup>	X				X	
Vital Signs <sup>e</sup>	X	X	X	X	X	
12-lead ECG <sup>f</sup>	X	X	X	X	X	
Pregnancy Test <sup>p</sup>	X	X	X	X	X	
Clinical Laboratory Testing <sup>g</sup>	X	X	X	X	X	

Clinical Variable	Screening		Treatment Period 1		Treatment Period 2		Follow-up
	Visit 1	Visit 2 <sup>n</sup> Day 1	Visit 3 <sup>n</sup> Day 15	Visit 4 <sup>n</sup> Day 1	Visit 5 <sup>n</sup> Day 15	Telephone Call	
Study Day	-7 up to -21 <sup>a</sup>	Day 1 <sup>a</sup>	Day 15 ±5 Days	Day 1	Day 15 ±5 Days	7 to 10 days	
Adjust COPD Medications <sup>i</sup>	X				X		
Adverse Events <sup>q</sup>		X	X	X	X	X	
Inhalation Device Training <sup>k</sup>	X <sup>j</sup>						
Inhalation Profile <sup>o</sup>		X		X			
Recording of Inhalation Profile with Respiration Belt <sup>o</sup>		X		X			
HRCT scan <sup>t</sup>		X	X	X	X		
Study Drug Dispensing/Collection <sup>l</sup>	X	X	X	X	X		
Randomization		X					
Study Drug Administration <sup>l</sup>		X	X	X	X		
Review/Record Study Drug Dose Indicator Reading <sup>m</sup>		X	X	X	X		
Review/Record Ventolin Dose Indicator Reading <sup>u</sup>	X	X	X	X	X		
Telephone contact							X

Abbreviations: CAT=COPD assessment test; MMRC= Modified Medical Research Council; ECG=electrocardiogram; COPD=Chronic obstructive pulmonary disease; HRCT=High-resolution computed tomography; ICS=inhaled corticosteroids; MDI=metered dose inhaler; FRC= functional residual capacity; TLC=total lung capacity

<sup>a</sup> Scheduling visits: The maximum run-in period is 21 days. The earliest a subject can be randomized from the Visit 1 date is 7 days (7 days for LABA washout). The site should make every effort to maintain subjects within the scheduled visit window.

- b At all visits beyond Visit 1 (Screening), note the time of last dose of COPD medications, including rescue medication and ICS (if <6 hours, visit should be rescheduled, except for sponsor-provided Atrovent<sup>®</sup> HFA at Visit 2 and Visit 4).
- c Refer to Section 7.1.2 for spirometry assessments and specific timepoints to be performed at each treatment visit.
- d Includes evaluation of height and weight at Visit 1.
- e Refer to Section 7.2.2 for vital sign assessments and specific timepoints to be performed at each visit.
- f Refer to Section 7.2.3 for ECG assessments and specific timepoints to be performed at each visit.
- g Refer to Section 7.2.4 for clinical laboratory assessments (hematology, chemistry and urinalysis and specific timepoints at each study visit).
- h Obtain a new chest x-ray if the chest x-ray or CT scan performed within 6 months of Visit 1 (Screening) is not available.
- i After obtaining informed consent subjects will be instructed to withhold prohibited COPD medications 6 hours to 24 hours before Visit 1 (Screening). At Visit 1 (Screening), subjects will be given Sponsor provided Atrovent HFA with or without ICS, rescue Ventolin HFA only after a subject is determined to be eligible to proceed to Visit 2 (Day 1) (i.e., only if a subject meets the definition of COPD following spirometry assessments at Screening).
- j At Visit 1 COPD medications will be changed as specified in the protocol (i.e., Sponsor provided Atrovent HFA with or without ICS). At the end of Visit 5, return subject to pre-study or other appropriate inhaled maintenance COPD medications.
- k Site should use the sponsor provided placebo MDI to train subjects on the use of MDIs.
- l In-clinic dosing time is recorded as time of the second puff/inhalation.
- m Refer to Appendix 6 for details and instructions on recording dose indicator readings.
- n Visit windows during each Treatment Period are relative to Day 1 of that Treatment Period. Washout period between Visit 3 and Visits 4 is a minimum of 5 days to a maximum of 21 days.
- o The inhalation profile with the use of the respiration belt will be measured simultaneously with the drug administration.
- p Only in female of childbearing potential.
- q AEs that occur before randomization will be summarized as medical history and not as a TEAE unless the event meets the definition of a SAE (Refer to Section 7.3.3).
- r All prescription and OTC medications taken by the subject within 30 days before Visit 1 (Screening) will be recorded.
- s The number of COPD exacerbations requiring oral steroids and/or oral antibiotics, or hospitalization within 12 months of Visit 1 (Screening) will be collected.
- t At Visit 2 and 4 two breathing levels: TLC and FRC. During Visit 2 an additional scan of the UA will be taken. At Visit 3 and 5 one breathing level: TLC.
- u Subjects who are unable to meet the compliance requirement (>70% subject completion of diary assessments) in the last 7 days preceding the Randomization Visit (Visit 2) must be retrained. When retraining is required due to non-compliance the Randomization Visit (Visit 2) must be rescheduled.

**Note:** Site should plan to perform these activities so as not to interfere with collection of timed assessments such as spirometry. Where data collection time-points are concurrent, variables must be collected in the following order: On Day 1 of each treatment period: *Pre-dose:* Urine pregnancy test, Spirometry (obtain FEV<sub>1</sub> to evaluate stability criteria), vital signs, ECG, clinical laboratory assessments (Abnormal eGFR at Visit 1 (screening) must be repeated prior to Visit 2 and have the results available at Visit 2 to confirm eligibility), Pre-dose CT scans, Spirometry, Body Plethysmography, Inhalation Profile. *Postdose:* vital signs, ECG. On Day 15 ( $\pm$  5 days) of each TP: *Pre-dose:* Urine pregnancy test, vital signs, ECG, clinical laboratory assessments *Postdose:* Vital signs, ECG, post-dose CT Scan, Spirometry, Body Plethysmography.

**Table 8-10: Timed Assessments at Visit 2 and Visit 4**

Clinical Variable <sup>a</sup>	Visit 2 (Day 1 TP 1)		Visit 4 (Day 1 TP 2)	
	Pre-dosing	Post-dosing	Pre-dosing	Post-dosing
	-60 min <sup>h</sup>	90 min <sup>h</sup>	-60 min <sup>h</sup>	90 min <sup>h</sup>
	-30 min <sup>h</sup>		-30 min <sup>h</sup>	
Vital Signs <sup>b,c,d</sup>	X	X	X	X
ECG <sup>b,c</sup>	X	X	X	X
Clinical Laboratory Testing <sup>b,c</sup>	X		X	
Urine pregnancy test <sup>e</sup>	X		X	
Spirometry <sup>c</sup>	X <sup>i</sup>		X <sup>i</sup>	
HRC <sup>T</sup> Scans <sup>c</sup>		X		X
Body Plethysmography <sup>c</sup>		X <sup>f</sup>		X <sup>f</sup>
Inhalation Profile <sup>c</sup>		X <sup>g</sup>		X <sup>g</sup>

- a. At the start of each treatment visit, subject must withhold all inhaled COPD medications, including study medication, rescue Ventolin HFA and ICS for at least 6 hours prior to start of test day procedures (except for sponsor-provided Atrovent® HFA at Visit 2 and Visit 4).
- b. This is not a timed assessment. Sites should plan to perform these activities so as not to interfere with collection of timed assessments such as spirometry.  
**Note:** Subjects with a calculated creatinine clearance  $< 30$  ml/min/1.73 m<sup>2</sup> MDRD at Visit 1 must have a eGFR<sub>MDRD</sub>  $> 30$  ml/min/1.73 m<sup>2</sup> on the repeat testing prior to Visit 2 to be randomized in this study.
- c. Refer to [Section 7](#) for specific assessments and specific time points to be performed at each treatment visit.
- d. Pre-dose vital signs include the temperature measurement.
- e. Urine pregnancy test should be performed at the beginning of the visit
- f. Spirometry and body plethysmography will be measured after the HRCT scan is taken.
- g. At the moment of this measurement the signal from the respiration belt, used for the measurement of the inhalation profile during the study drug administration, will also be logged.
- h. The timepoints are preferred timepoints, the site should make every effort to respect the timepoints as good as possible.
- i. Will be performed at the beginning of the visit. At Visit 4 the obtained -60 minute FEV<sub>1</sub> value will be used to check the stability criteria

**Note:** Site should plan to perform these activities so as not to interfere with collection of timed assessments such as spirometry. Where data collection time points are concurrent, variables must be collected in the following order: *Pre-dose:* Urine pregnancy test, spirometry (obtaining FEV<sub>1</sub> to check stability criteria), vital signs, ECG, clinical laboratory assessments, pre-dose CT scans, spirometry, body plethysmography, inhalation profile. *Post-dose:* Vital signs, ECG.



**Table 8-11: Timed Assessments at Visit 3 and Visit 5**

Clinical Variable <sup>a</sup>	Visit 3 (Day 15 TP 1)		Visit 5 (Day 15 TP 2)	
	Pre-dosing		Pre-dosing	
	-60 min <sup>g</sup>	-30 min <sup>g</sup>	-60 min <sup>g</sup>	-30 min <sup>g</sup>
Vital Signs <sup>b,c,d</sup>	X		X	
ECG <sup>b,c</sup>	X		X	
Clinical Laboratory Testing <sup>b,c</sup>			X	
Urine pregnancy test	X <sup>h</sup>		X <sup>h</sup>	
HRCT Scans <sup>e</sup>				X <sup>e</sup>
Body Plethysmography <sup>f</sup>				X <sup>f</sup>
Spirometry <sup>c</sup>	X		X	X <sup>f</sup>

- a. At the start of each treatment visit, subject must withhold all inhaled COPD medications, including study medication, rescue Ventolin HFA and ICS for at least 6 hours prior to start of test day procedures.
- b. This is not a timed assessment. Sites should plan to perform these activities so as not to interfere with collection of timed assessments such as spirometry.
- c. Refer to [Section 7](#) for specific assessments and specific time points to be performed at each treatment visit.
- d. Pre-dose vital signs include the temperature measurement.
- e. At one breathing level: TLC. Will be performed before the post-dose spirometry and body plethysmography.
- f. Spirometry followed by body plethysmography will be performed after the HRCT scans but within 150min after dosing.
- g. The timepoints are preferred timepoints, the site should make every effort to respect the timepoints as good as possible. None of the post dose assessments will start before 1 hour after the administration and all assessmentst will be concluded within 2.5hours after dosing.
- h. Urine pregnancy test should be performed at the beginning of the visit.  
**Note:** Site should plan to perform these activities so as not to interfere with collection of timed assessments such as spirometry. Where data collection time-points are concurrent, variables must be collected in the following order: Predose: Urine pregnancy test, spirometry, vital signs, ECG, clinical laboratory assessments  
Postdose: Vital signs, ECG post-dose CT scan, spirometry, body plethysmography.

## 8.1 Visit 1 (Screening)

- Obtain informed consent prior to or at the beginning of Visit 1 prior to conducting any study related procedures
- Determine time of last dose of prohibited COPD medication as defined in table 5-1
- Site will assign subject screening number
- Review inclusion/exclusion criteria
- Obtain demographic data, including age, race, smoking history, medical/surgical history, and age of onset of COPD
- Obtain medication history, including COPD medications.
- Conduct a urine pregnancy test for all female subjects of childbearing potential unless it is documented in the medical history that the subject has been irreversibly surgically sterilized (hysterectomy, oophorectomy, or bilateral tubal ligation) or they are at least 2 years post-menopausal.
- Conduct a complete physical examination of relevant body parts.
- Obtain height, weight, and vital signs (heart rate and blood pressure after being supine or seated for 5 minutes, and oral or tympanic temperature).
- Obtain a 12-lead ECG.
- Obtain CAT and MMRC
- Conduct spirometry assessments including IC and diffusion capacity.
- Perform reversibility test to Ventolin HFA (refer to [Section 7.1.2.1](#) for instructions)
- **Note:** Confirm subject continues to meet entry criteria based on pre- and post-dose spirometry quality (refer to [Section 5.1](#)).
- Confirm subject's ability to use MDI correctly (provide coaching with sponsor-provided placebo MDI).
- If subject qualifies to continue to Visit 2 perform the following:
  - Obtain laboratory samples (hematology, chemistry and urinalysis).
  - If Chest X-ray or CT within 6 months of Visit 1 (Screening) is not available, obtain a new Chest X-ray.
  - Change concurrent COPD medications as specified in protocol (refer to [Section 5.4.1](#)). Sponsor will provide Atrovent HFA QID for COPD maintenance and Ventolin HFA as needed for symptomatic relief.
  - Schedule Visit 2.
- In order to allow for an adequate washout of previous maintenance medications, subjects will undergo a run-in period of at least 1 week, but not greater than 21 days (2 weeks if subject is taking Spiriva or other Long-acting anticholinergics) in duration prior to returning to the clinic for Visit 2.

- Dispense and train subject on Diary use
- Ensure subject has adequate supply of sponsor-provided Atrovent<sup>®</sup> HFA and sponsor-provided rescue Ventolin<sup>®</sup> HFA.
- Record the number of actuations of the Ventolin<sup>®</sup> canister at the time of dispensing (following priming and characterization of reversibility).
- Subjects will be instructed to bring the Diary, the sponsor-provided Ventolin<sup>®</sup> HFA and Atrovent<sup>®</sup> HFA to the next scheduled clinic visit.
- Subjects will be instructed to administer sponsor-provided Atrovent<sup>®</sup> HFA the morning of Visit 2 5-6 hours prior to the anticipated time of the post-dose CT scan
- AEs must be recorded during the run-in period, that is, from the time of consent to the start of study treatment.

**Note:** AEs that occur between the time the subject signs the ICF for the study and the time when that subject is dosed with study drug will be summarized as medical history and not as a study AE, unless the event meets the definition of a SAE.

## 8.2 Visit 2 (Randomization: Day 1 of TP 1)

- Review subject diary entries and retrain subject if subject has not met diary compliance requirement of >70% subject completion of diary assessments.
- Collect sponsor-provided Atrovent HFA and sponsor-provided Ventolin HFA dispensed during the Screening run-in period.
- Record the number of actuations of the Ventolin HFA canister.
- Determine time of last dose of short-acting bronchodilator and other inhaled COPD medications
- Review all prior medications and ensure adherence to COPD regimen.
- Review inclusion/exclusion criteria and confirm subject eligibility to continue.
- If not previously reviewed, review of clinical laboratory results from Visit 1. Please note whether the results are clinically significant and include comments where applicable.

**Note:** Subjects with a calculated creatinine clearance  $< 30 \text{ ml/min/1.73 m}^2$  estimated using the Modification of Diet in Renal Disease Equation (eGFR<sub>MDRD</sub>) at Visit 1 and on repeat testing prior to Visit 2 will be excluded.

- Record AEs (if any).  
**Note:** AEs that occur during the run-in period (Visit 1 to Visit 2,) will be summarized as medical history and not as a study AE unless the event meets the definition of a SAE.
- Update medical history if needed.
- Update smoking status if needed.
- Conduct a urine pregnancy test for all female subjects of childbearing potential unless it is documented in the medical history that the subject has been irreversibly surgically

sterilized (hysterectomy, oophorectomy, or bilateral tubal ligation) or they are at least 2 years post-menopausal.

- Perform all pre-dose assessments (refer to [Table 8-10](#)):
  - Obtain Spirometry (baseline FEV<sub>1</sub> will be obtained)
  - Obtain Vital signs (heart rate and blood pressure after being supine or seated for 5 minutes, and oral or tympanic temperature).
  - Obtain 12-lead ECG.
  - Obtain laboratory samples (hematology, chemistry and urinalysis).
  - Obtain HRCT scans: TLC + FRC + UA.

**Note:** Review inclusion/exclusion criteria, repeat testing of the creatinine clearance prior to Visit 2, if necessary. Creatinine clearance eligibility must be known before the HRCT scan can be taken.

- Obtain Spirometry (including IC).
  - Obtain body plethysmography
  - Obtain Inhalation Profile (body plethysmograph while wearing respiration belts)
  - Obtain subject randomization number and treatment assignment information. The subject is to be considered randomized after receiving a randomization number.
  - To allow for proper preparation of study drug, it is recommended that the seal around the study day treatment box is opened 15-30 minutes prior to dosing and the instructions for administration of study drug followed. Refer to [Section 6.7](#) for detailed instructions for preparation of treatments for administration. These instructions are to be adhered to and are relevant to all study treatment visits.
  - Record/document the dose indicator reading. The dose indicator count recorded by the site staff on Day 1 of the TP will be after priming the medication (prior to the first dosing) and after the first dosing. Refer to [Section 7.1.9](#) for more details.
  - Subject will administer first dose of newly assigned study drug at the clinic. During dosing the inhalation profile with the respiration belts will be recorded.
  - Record/document the dose indicator reading after subject dosing.
  - Subject will be instructed to dose while at home from the site-primed MDI **only**, unless all of the following **replacement conditions** are met:
    - Dose indicator is in the red zone (refer to [Appendix 6](#) for dose indicator reading instructions).
    - The dose indicator registers  $\leq 10$  puffs remaining, **and** their next scheduled study clinic visit is not the following day.
- If these replacement conditions are met, subjects will be instructed to open their replacement kit, prime the MDI and start using for at home dosing until the next scheduled study clinic visit.
- Perform all post-dosing assessments (refer to [Table 8-10](#)):

- Obtain post-dose Vital signs (heart rate and blood pressure after being supine or seated for 5 minutes).
- Obtain post-dose 12-lead ECG.
- Schedule Visit 3.  
**Note:** Visit 3 should be scheduled at minimum 10 days after Visit 2 and no later than 20 days after Visit 2.
- Ensure subject has adequate supply of study medication (including sponsor-provided rescue Ventolin HFA).
- Subjects will be instructed to bring all study medication (including used study drug, replacement MDI kit and sponsor-provided rescue Ventolin HFA) and the Diary to the next scheduled clinic visit.

### 8.3 Visit 3 (Day 15 ± 5 days of TP 1)

- Determine time of last dose of short-acting bronchodilator and other inhaled COPD medications (if <6 hours, the visit must be rescheduled).
- Confirm the subject took their last dose of randomized study medication as scheduled the prior evening.
- Record/document the dose indicator reading of the used MDI.
- Record the number of actuations of the Ventolin HFA canister.
- Record COPD exacerbations and AEs (if any).
- Review all concomitant medications and ensure adherence to COPD regimen.
- Update smoking status if needed.
- Review subject diary entries
- Conduct a urine pregnancy test for all female subjects unless it is documented in the medical history that the subject has been irreversibly surgically sterilized (hysterectomy, oophorectomy, or bilateral tubal ligation) or they are at least 2 years post-menopausal.
- Perform all pre-dose assessments (refer to [Table 8-11](#)):
  - Obtain Vital signs (heart rate and blood pressure after being supine or seated for 5 minutes, and oral or tympanic temperature).
  - Obtain 12-lead ECG.
  - Obtain laboratory samples (hematology, chemistry and urinalysis).
  - Obtain Spirometry (including IC).
- Administer last in-clinic study drug dose of TP 1.
- Perform all post-dosing assessments (refer to [Table 8-11](#)). All post-dose assessments must be performed between 1 to 2.5 hours after drug administration.

- Obtain Vital signs (heart rate and blood pressure after being supine or seated for 5 minutes).
- Obtain 12-lead ECG.
- Obtain HRCT scan: TLC.
- Obtain Spirometry (including IC).
- Obtain body plethysmography.
- Schedule Visit 4.  
**Note:** Visit 4 should be scheduled at minimum 5 days after Visit 3 and no later than 21 days after Visit 3.
- Ensure subject has adequate supply of sponsor-provided Atrovent HFA and sponsor-provided rescue Ventolin HFA.
- Subjects will be instructed to bring the Diary, the sponsor-provided Atrovent HFA and Ventolin HFA to the next scheduled clinic visit.
- Subjects will be instructed to administer sponsor-provided Atrovent<sup>®</sup> HFA the morning of Visit 4 5-6 hours prior to the anticipated time of the post-dose CT scan.

#### 8.4 Visit 4 (Day 1 of TP 2)

- Collect sponsor-provided Atrovent HFA and sponsor-provided Ventolin HFA dispensed during the washout period.
- Record the number of actuations of the Ventolin HFA canister.
- Determine time of last dose of short-acting bronchodilator and other COPD medications.
- Review all concomitant medications and ensure adherence to COPD regimen.
- Update smoking status if needed.
- Review inclusion/exclusion criteria and confirm subject eligibility to continue.
- Record COPD exacerbations and AEs (if any).
- Conduct a urine pregnancy test for all female subjects of childbearing potential unless it is documented in the medical history that the subject has been irreversibly surgically sterilized (hysterectomy, oophorectomy, or bilateral tubal ligation) or they are at least 2 years post-menopausal.
- Complete all pre-dose assessments (refer to [Table 8-10](#)):
  - Obtain Spirometry  
**Note:** Confirm if patient meets stability requirements, if not the visit may be rescheduled within the allowed visit window, at the Investigator's discretion, or the subject may be discontinued.
    - Obtain Vital signs (heart rate and blood pressure after being supine or seated for 5 minutes, and oral or tympanic temperature).
    - Obtain 12-lead ECG.



- Obtain laboratory samples (hematology, chemistry and urinalysis).
  - Obtain HRCT scans: TLC + FRC.  
**Note:** Review inclusion/exclusion criteria, before the HRCT scan can be taken!
  - Obtain Spirometry (including IC).
  - Obtain body plethysmography.
  - Obtain inhalation profile (body plethysmograph while wearing respiration belts).
  - To allow for proper preparation of study drug, it is recommended that the seal around the study day treatment box is opened 15-30 minutes prior to dosing and the instructions for administration of study drug followed. Refer to [Section 6.7](#) for detailed instructions for preparation of treatments for administration. These instructions are to be adhered to and are relevant to all study treatment visits.
  - Record/document the dose indicator reading. The dose indicator count recorded by the site staff will be dose indicator count observed after priming the medication and prior subject dosing. Refer to [Section 7.1.9](#) for more details.
  - Subject will administer first dose of newly assigned study drug at the clinic. During dosing the inhalation profile with the respiration belts will be recorded.
  - Record/document the dose indicator reading after subject dosing.
  - Subject will be instructed to dose while at home from the site-primed MDI **only**, unless all of the following **replacement conditions** are met:
    - Dose indicator is in the red zone (refer to [Appendix 6](#) for dose indicator reading instructions)
    - The dose indicator registers  $\leq 10$  puffs remaining, **and** their next scheduled study clinic visit is not the following day.
- If these replacement conditions are met, subjects will be instructed to open their replacement kit, prime the MDI and start using for at home dosing until the next scheduled study clinic visit.
- Perform all post-dosing assessments (refer to [Table 8-10](#)):
    - Obtain Vital signs (heart rate and blood pressure after being supine or seated for 5 minutes).
    - Obtain 12-lead ECG.
  - Schedule Visit 5.  
**Note:** Visit 5 should be scheduled at minimum 10 days after Visit 4 and no later than 20 days after Visit 4.
  - Ensure subject has adequate supply of all study medication including sponsor-provided rescue Ventolin HFA.
  - Subjects will be instructed to bring all study medication (including used study drug, replacement MDI kit, and rescue Ventolin HFA) and the Diary to the next scheduled clinic visit.

## 8.5 Visit 5 (Day 15 ± 5 days of TP 2)

- Determine time of last dose of short-acting bronchodilator and other inhaled COPD medications (if <6 hours, the visit must be rescheduled).
- Confirm the subject took their last dose of randomized study medication as scheduled the prior evening.
- Record/document the dose indicator reading of the used MDI.
- Record the number of actuations of the Ventolin HFA canister.
- Record COPD exacerbations and AEs (if any).
- Review all concomitant medications and ensure adherence to COPD regimen.
- Update smoking status if needed.
- Review subject diary entries.
- Conduct a urine pregnancy test for all female subjects unless it is documented in the medical history that the subject has been irreversibly surgically sterilized (hysterectomy, oophorectomy, or bilateral tubal ligation) or they are at least 2 years post-menopausal.
- Perform all pre-dose assessments (refer to [Table 8-11](#)):
  - Obtain Vital signs (heart rate and blood pressure after being supine or seated for 5 minutes, and oral or tympanic temperature).
  - Obtain 12-lead ECG.
  - Obtain laboratory samples (hematology, chemistry and urinalysis).
  - Obtain Spirometry (including IC).
- Administer in-clinic last study drug dose of TP 2
- Perform all post-dosing assessments (refer to [Table 8-11](#)). All post-dose assessments must be performed between 1 to 2.5 hours after drug administration:
  - Obtain Vital signs (heart rate and blood pressure after being supine or seated for 5 minutes).
  - Obtain 12-lead ECG.
  - Obtain HRCT scan: TLC.
  - Obtain Spirometry (including IC).
  - Obtain body plethysmography.
- Conduct a complete physical examination of relevant body parts.
- Schedule a follow-up TC 7 to 10 days post last study drug dosing.
- Collect all study medication including sponsor-provided Ventolin HFA.
- At completion of all Visit 5 assessments, return subject to pre-study or appropriate maintenance COPD medications.

## 8.6 Unscheduled Visit/Premature Discontinuation Visit

Repeat assessments, if needed, will be captured in unscheduled visits.

Premature Discontinuations Visits will be captured as unscheduled visits. The following minimum procedures should be completed at the Premature Discontinuation Visit:

- Record COPD exacerbations and AEs (if any).
- Review concomitant medications.
- Conduct a physical examination, including vital signs (heart rate and blood pressure after being supine or seated for 5 minutes, and oral or tympanic temperature).
- Perform ECG and collect blood samples for hematology and chemistry.
- Collect a urine sample for urinalysis for lab safety.
- Conduct a urine pregnancy test for all female subjects of childbearing potential.
- Collect all study drugs.
- Inform subject about reporting all SAEs up to 10 days following the last dose of study drug.
- Return subject to pre-study or appropriate maintenance COPD medications.
- Capture the subject discontinuation reason.
- Schedule a follow-up TC 10 days post last study drug dosing. If the discontinuation visit is performed >10 days post last study drug dosing a follow-up TC will not be required.

## 8.7 Follow-Up Telephone Call

Subjects will be followed-up through telephone contact 7 to 10 days post last study drug dosing. The following information will be requested:

- Review previously on-going SAEs, and record new SAEs (if any).
- Review concomitant medications.
- Review smoking status.

## 8.8 Completion of the Study

The Investigator will document the completion or the reason for early withdrawal by a subject in the eCRF. The following categories should be used to describe these events in the eCRF:

- Subject discretion (document reason).
- Investigator considers it to be in the best interest of the subject.
- AEs.
- Administrative reasons (eg, early termination of the study).
- Subject lost-to-follow-up.
- Lack of efficacy.
- Major protocol violation.
- Death.
- Completion of the study.
- Protocol specified criteria such as heart rate, systolic or diastolic blood pressure, or use of prohibited medications (refer to [Section 5.7](#)).

## 9 PLANNED STATISTICAL METHODS

### 9.1 Introduction

This study will be conducted as a single-center, randomized, double-blind (GFF and Placebo MDIs), two treatment period, chronic dosing (2 weeks), two-treatment, and crossover design evaluating the following two treatments in approximately 20 subjects:

- GFF MDI 14.4/9.6 µg BID
- Placebo MDI BID

The primary objective of this study is to assess the effect of treatment with GFF MDI, 14.4/9.6 µg ex actuator, BID relative to Placebo MDI on specific image based airway volumes and resistance in subjects with moderate to severe COPD.

### 9.2 Protocol Variables

#### 9.2.1 Efficacy Endpoints

The first day of treatment in each TP is Day 1. Each TP is planned to contain 15 days ( $\pm 5$  days) between the first and last dose corresponding to a span of 15 calendar days. Therefore, assessments collected on Day 15 (Visits 3 and 5) will occur following 14 days of treatment. All FRI, spirometry and body plethysmography endpoints will utilize changes from baseline.

##### 9.2.1.1 Primary Efficacy Endpoints on Day 1 and Day 15, except as otherwise noted

#### FRI Parameters:

- $_{si}V_{aw}$
- $_{si}R_{aw}$

##### 9.2.1.2 Secondary Efficacy Endpoints measured on Day 1 and Day 15, except as otherwise noted

#### FRI Parameters:

- Airway volume (iVaw)
- Airway resistance (iRaw)

#### Spirometry Parameters:

- Forced expiratory volume in one second ( $FEV_1$ )

**Body Plethysmography Parameters:**

- FRC

**9.2.1.3 Other Efficacy Endpoints measured on Day 1 and Day 15, except as otherwise noted**

**FRI Parameters:**

- Lobe volumes (iVlobes)
- Air trapping
- Internal lobar airflow distribution
- Low attenuation or emphysema score
- Blood vessel density or fibrosis score
- Airway wall thickness
- Mass of deposited particles per defined airway section

**Spirometry Parameters:**

- Forced vital capacity (FVC)
- Tiffeneau index ( $FEV_1/FVC$  ratio)
- Forced expiratory flow 25%-75% ( $FEF_{25-75}$ )
- Inspiratory capacity (IC)

**Body Plethysmography Parameters:**

- Residual volume (RV)
- TLC
- Airway resistance (Raw)
- Specific airway resistance (sRaw)
- Specific airway conductance (sGaw)

#### 9.2.1.4 Safety Endpoints

- AEs

### 9.3 Efficacy Analyses

#### 9.3.1 Efficacy Analysis

For the efficacy analyses, the null hypothesis for each pair-wise comparison will be that the mean GFF MDI treatment effect is equal to that of Placebo MDI; the alternative hypothesis is then that the GFF MDI treatment effect and that of Placebo MDI (or an individual component) are not equal. P-values will thus be reported as two-sided. The effect is defined as the difference between the value at Day 15 ( $\pm 5$  days) and the value at Day 1. Effect is thus defined as the change from baseline to placebo, for a placebo treatment and as the change from baseline to GFF MDI, for a GFF MDI treatment. The null ( $H_0$ ) and alternative ( $H_1$ ) hypotheses with  $\mu$  representing the mean value of the effect are:

$$H_0: \mu_{\text{GFF}} = \mu_{\text{placebo}}$$

$$H_1: \mu_{\text{GFF}} \neq \mu_{\text{placebo}}$$

For each parameter in each group (primary efficacy endpoints: FRI; secondary efficacy endpoints: FRI, spirometry and body plethysmography; other efficacy endpoints: all FRI parameters except the mass of deposited particles, spirometry and body plethysmography), this null hypothesis will be tested. A linear mixed model approach will be chosen and specified fully in the statistical analysis plan.

In order to gain extra insights in the mode of action of the product, additional exploratory analyses can be executed using (robust) linear regression or mixed-models.

The Intent-to-Treat (ITT) Population will be considered the primary analysis population for efficacy. Supportive analyses will be conducted with the Modified Intent-to-Treat (mITT) Population.

#### 9.3.2 Control of Type I error

For the primary efficacy endpoints, Hochberg's step-up procedure will be used as multiplicity adjustment. No correction will be performed for the secondary and the other efficacy endpoints.

#### 9.3.3 Safety Analysis

##### 9.3.3.1 Adverse Events

Adverse events during each TP will be summarized by the number of subjects experiencing an event. Tabulations will be broken down by severity, seriousness, AEs leading to discontinuation, and by relationship to study drug. No hypothesis tests will be performed. Tables will show the overall incidence of AEs, and the incidence for each treatment.



**Note:** Any clinically relevant findings from ECGs, clinical laboratory tests (e.g. Hematology, Clinical Chemistry), or vital sign measurements will be reported as adverse events.

## 9.4 Randomization

Subjects will be randomly assigned to one of two treatment sequences in a block size of 4 for the two sequences. Each sequence will include exactly one of the two treatment groups included in this study per TP. All subjects will receive GFF MDI 14.4/9.6 µg and Placebo MDI.

The two treatment sequences are shown below:

**Table 9-11: Randomization Schedule**

	Treatment period 1	Treatment period 2
Treatment sequence 1	GFF MDI (PT003) 14.4/9.6 µg ex-actuator	Placebo MDI
Treatment sequence 2	Placebo MDI	GFF MDI (PT003) 14.4/9.6 µg ex-actuator

## 9.5 Experimental design

The experimental design was chosen to be balanced with respect to period and first-order carryover effects.

## 9.6 Sample Size Consideration

In a double blind cross over study where 10 COPD Global Initiative for Chronic Obstructive Lung Disease (**GOLD**) III subjects received a budesonide/formoterol combination, FRI was able to quantify the effects of the active compound relative to placebo. A sample size calculation (power goal 90%, alpha 0.05) revealed that in order to have a well-powered study with change in imaging based airway volume as primary outcome parameter, a total of 7 subjects would be required ([De Backer, 2012](#)), while 17 subjects would need to be included for the image based airway resistance ([De Backer, 2012](#)). If the significance level for the volume is set to 0.025 by the Hochberg's step-up procedure, 8 subjects would be required. It can be assumed that a good power will be obtained when including 20 subjects.

## 9.7 Data Validation and Transformation

All measured values will be included in the analyses. Depending on the plots of the standardized residuals versus fitted values of the mixed-effect models, data transformations will be considered.

## 9.8 Analysis Plan

All analyses will be specified in a detailed Statistical Analysis Plan (SAP) that will include table and data listing shells with mock graphical representations. The SAP will be signed before database lock and unblinding.

## 9.9 Study Populations

The following analysis populations are defined in this study:

- The **ITT Population** is defined as all subjects who are randomized to treatment. Treatment is assigned as randomized regardless of the treatment actually received.
- The **modified Intent-to-Treat (mITT Population)** is a subset of the ITT Population including subjects who received treatment and have post-treatment efficacy data from both Treatment Periods. Data judged to be impacted by major protocol deviations will be determined prior to unblinding and excluded. Statistical tabulations and analyses will be by randomized treatment, but data obtained after subjects receive an incorrect treatment will be excluded from the affected periods.
- The **Safety Population** is defined as all subjects who are randomized to treatment and receive at least one dose of the study treatment. Statistical analyses and tabulations will be by the treatment actually received.

Analyses will be performed as follows:

Demographics will be summarized for the ITT, mITT and Safety populations. Extent of exposure will be summarized for the Safety Population. The Safety Population will be used to summarize safety data.

Efficacy analyses will be performed for the ITT and mITT Populations, with the ITT Population being considered the primary population for these analyses.

## 9.10 Handling of Missing Data

No imputation for missing values is planned.

## 9.11 Statistical Software

All analyses will be performed using the open-source statistical environment [REDACTED].

## **10 ADMINISTRATIVE CONSIDERATIONS**

### **10.1 Regulatory Authority Approval**

Pearl will obtain approval to conduct the study from the appropriate regulatory agency in accordance with any applicable country-specific regulatory requirements prior to a site initiating the study in that country.

### **10.2 Ethical Conduct of the Study and Institutional Review Board (IRB) or Independent Ethics Committee (IEC) Approval**

The study will be conducted in accordance with Good Clinical Practice (GCP). These standards respect the following guidelines:

- Guideline for Good Clinical Practice E6 (R1): Consolidated Guideline (ICH of Technical Requirements for the Registration of Pharmaceuticals for Human Use, May 1996).
- US CFR dealing with clinical studies (21 CFR parts 50, 54, 56, and 312).
- Declaration of Helsinki, concerning medical research in humans (Ethical Principles for Medical Research Involving Human Subjects) [<http://www.wma.net/en/10home/index.html>].
- Any additional regulatory requirements.

The Investigator (or Pearl, where applicable) is responsible for ensuring that this protocol, the site's ICF, and any other information that will be presented to potential subjects (eg, advertisements or information that supports or supplements the ICF) are reviewed and approved by the appropriate IRB/IEC. The Investigator agrees to allow the IRB/IEC direct access to all relevant documents. The IRB/IEC must be constituted in accordance with all applicable regulatory requirements.

Pearl will provide the Investigator with relevant document(s)/data that are needed for IRB/IEC review and approval of the study. If the protocol, the ICF, or any other information that the IRB/IEC has approved for presentation to potential subjects is amended during the study, the Investigator is responsible for ensuring the IRB/IEC reviews and approves, where applicable, these amended documents. The Investigator must follow all applicable regulatory requirements pertaining to the use of an amended ICF including obtaining IRB/IEC approval of the amended form before new subjects consent to take part in the study using this version of the form. The IRB/IEC approval of the amended ICF/other information and the approved amended ICF/other information must be forwarded to Pearl promptly.

### **10.3 Subject Information and Consent**

The study will be conducted in accordance with applicable subject privacy requirements. The proposed ICF, which must be in compliance with applicable regulations, must be reviewed and approved by the IRB/IEC and Pearl prior to initiation of the study.

The Investigator will be responsible for obtaining written informed consent from potential subjects prior to any study-specific screening and entry into the study. A copy of the signed ICF will be provided to the subject. The original will be retained by the Investigator.

#### **10.4 Laboratory Accreditation**

Any laboratory facility intended to be used for analysis of clinical laboratory samples required by this protocol must provide evidence of adequate licensure or accreditation according to the prevailing regulations in that state and/or country. Reference values and/or normal ranges for the test results must be provided to Pearl. Pearl must be notified promptly in writing of any changes occurring in reference values during the course of the study.

#### **10.5 Confidentiality**

##### **10.5.1 Confidentiality of Data**

By signing this protocol, the Investigator affirms to Pearl that information furnished to the Investigator by Pearl will be maintained in confidence and such information will be divulged to the IRB/IEC, or similar or expert committee; affiliated institution; and employees only under an appropriate understanding of confidentiality with such board or committee, affiliated institution and employees. Data generated by this study will be considered confidential by the Investigator, except to the extent that it is included in a publication.

##### **10.5.2 Confidentiality of Subject/Subject Records**

By signing this protocol, the Investigator agrees that Pearl (or representative), IRB/IEC, or Regulatory Agency representatives may consult and/or copy study documents in order to verify worksheet/case report form data. By signing the consent form, the subject/subject agrees to this process. If study documents will be photocopied during the process of verifying worksheet/case report form information, the subject/subject will be identified by unique code only; full names/initials and full birth year will be masked prior to transmission to Pearl. In addition, the Investigator agrees to treat all subject data used and disclosed in connection with this study in accordance with all applicable laws (ie, Health Insurance Portability and Accountability Act), rules and regulations.

#### **10.6 Quality Control and Assurance**

[REDACTED] is responsible for implementing and maintaining quality control and quality assurance systems with written standard operating procedures (SOPs) to ensure that trials are conducted and data are generated, documented, and reported in compliance with the protocol, accepted standards of GCP, and all applicable federal, state, and local laws, rules and regulations relating to the conduct of the clinical study.

#### **10.7 Data Management**

Data management procedures and information for this protocol will be provided by Pearl or their designee.

## 10.8 Study Monitoring

In accordance with applicable regulations, GCP, and Pearl procedures, clinical monitors will contact the site prior to subject enrollment to review the protocol and data collection procedures with site staff. In addition, the monitor will periodically contact the site, including conducting on-site visits. The extent, nature, and frequency of on-site visits will be based on such considerations as the study objective and/or endpoints, the purpose of the study, study design complexity, and enrollment rate.

During these contacts, the monitor will:

- Check the progress of the study.
- Review study data collected.
- Conduct source document verification.
- Identify any issues and address their resolution.

This will be done in order to verify that the:

- Data are authentic, accurate, and complete.
- Safety and rights of subjects are being protected.
- Study is conducted in accordance with the currently approved protocol (and any amendments), GCP, and all applicable regulatory requirements.

The Investigator agrees to allow the monitor direct access to all relevant documents and to allocate his/her time and the time of his/her staff to the monitor to discuss findings and any relevant issues.

Upon completion of the study, the monitor will conduct the following activities in conjunction with the Investigator or site staff, as appropriate:

- Return of all study data to Pearl.
- Data queries.
- Accountability, reconciliation, and arrangements for unused investigational product(s).
- Review of site study records for completeness.

After the final review of the study files, the files should be secured for the appropriate time period as specified in [Section 10.9](#). The Investigator will also permit inspection of the study files by Pearl' Quality Assurance auditors, and authorized representatives of the FAGG or other applicable regulatory agencies.

## 10.9 Retention of Data

Documents that individually and collectively permit evaluation of the conduct of the study and the quality of the data produced must be maintained for review by Pearls' quality assurance auditors and by all applicable regulatory authorities. The period of time these documents must be maintained is governed by applicable regulations. Pearl or its designee will inform the Investigator when these documents may be destroyed.

## 10.10 Financial Disclosure

The principal Investigator or sub-Investigators named on the Form FDA 1572 will need to complete a financial disclosure form prior to study initiation, at any time during the study execution if new information needs to be disclosed, and for 1 year after study completion. Investigators should make the IRB/IEC aware of any financial interests that the Investigator has in the investigational product.

## 10.11 Investigator's Final Report

Shortly after completion of the Investigator's participation in the study, the Investigator will submit a written report to Pearl.

## 10.12 Publication Policy

Pearl intends to publish the results of all of the clinical studies that it sponsors in compliance with the Declaration of Helsinki (<http://www.wma.net/en/10home/index.html>). Consistent with the recommendations of the editors of several leading medical journals, the International Committee of Medical Journal Editors (ICMJE), authorship of publications resulting from Pearl -sponsored studies should fairly recognize the activities of those that have made a significant contribution to the study. Thus, it is anticipated that authorship will reflect the contribution made by Pearl personnel, the Investigators and others involved, such as statisticians.

In recent years, issues about conflicts of interest and accuracy of the study data have been raised in the medical press. Accordingly, Pearl has developed publication guidelines as described below:

1. **Responsibility:** Each principal Investigator is responsible for the accuracy and completeness of all data from their site. Pearl (or its representatives) is responsible for the accuracy of the data entered into the study databases and for the accuracy of the analyses conducted.
2. **Authorship and Publication Committee:** Pearl, in collaboration with the Investigators, will establish the appropriate authorship and responsibility for drafting study documents in accordance with the principles of the ICMJE. It is anticipated that a publication committee will be formed to assume oversight of these activities. All manuscripts will be reviewed and agreed upon before submission for publication by all authors.
3. **Sponsor Review of External Manuscripts:** Consistent with the previous bullet point, drafts of any and all publications or presentations that may arise from this study must be

submitted at least 30 days prior to submission for publication or presentation to Pearl for review, approval, and to ensure consistency with the policy in this protocol. Pearl will have the right to request appropriate modification to correct facts and to represent its opinions, or the opinions of the publication committee, if these differ with the proposed publication.

4. **Confidentiality:** Investigators will conduct all interactions with Pearl and with third parties consistent with the executed confidentiality agreements. While publication, by intention, presents the critical scientific data in a public forum, some information (such as future plans, results of nonclinical studies, or chemical formulae) may still need to remain confidential.
5. **Medical Journal Review:** Consistent with the intention of Pearl to publish the study in a fair and accurate manner, Pearl supports diligence in the publication review process of medical journals. Accordingly, upon request, all pertinent study data and information will be made available as supplemental information for journal editors and reviewers to evaluate and audit, eg, protocol and amendments, data tabulations, etc. The journal and reviewers will need to make arrangements to maintain the confidentiality of such supplemental information, where relevant, and Pearl will make suitable arrangements to ensure that the identity of journal reviewers is kept confidential. Records will be maintained of reviewers and the respective documents and datasets that were reviewed by each of them.
6. **Reporting of Clinical Trials Results:** To provide transparency in the conduct and reporting of randomized clinical trials, Pearl reports clinical findings based on the guidance of The CONSORT (Consolidated Standards of Reporting Trials) Statement [[CONSORT, 2010](#)] and a 25-item checklist which is intended to improve the reporting of a randomized controlled trial, and to facilitate reader understanding of the trial design, conduct, analysis and interpretation, and to support their ability to assess the validity of its results.
7. **Internet Clinical Trial Listing:** In addition, also consistent with the recommendations of the ICMJE, Pearl will make available appropriate information regarding the study via the internet. This will include registration and listing of the study on [www.clinicaltrials.gov](http://www.clinicaltrials.gov), the US National Institutes of Health listing of clinical trials, and other clinical trial listings as appropriate.



## 11 REFERENCE LIST

Atrovent Prescribing Information (US), [REDACTED], 2012.

Calverley P, Lee A, Towse L, et al. Effect of tiotropium bromide on circadian variation in airflow limitation in chronic obstructive pulmonary disease. *Br Medical J*. 2003;58(10):855–860.

Consolidated Standards of Reporting Trials (CONSORT) Statement 2010. Accessed on 17 July 2014. Available online at: <http://www.consort-statement.org/consort-2010>

COPD Assessment Test (CAT) (<http://www.catestonline.org/>).

Celli B, MaNee W, Agusti A, et al. Standards for the diagnosis and treatment of subjects with COPD: a summary of the ATS/ERS position paper. *Eur Respir J* 2004; 23:932-946.

De Backer L, Vos W, De Backer J, Van Holsbeke C, Vinchurkar S, De Backer W. The acute effect of budesonide/formoterol in COPD: a multi-slice computed tomography and lung function study. *Eur Respir J*. 2012 Aug 1;40(2):298–305.

De Backer L, Vos W, Salgado R, De Backer J, Devolder A, Verhulst S, et al. Functional imaging using computer methods to compare the effect of salbutamol and ipratropium bromide in subject-specific airway models of COPD. *Int J Chron Obstruct Pulmon Dis*. 2011;6:637–46.

European Medicines Agency. EMA/CHMP/508029/2012 Committee for Medicinal Products for Human Use (CHMP). Assessment Report Seebri Breezhaler. Accessed on 24 July 2014, online:[http://www.ema.europa.eu/docs/en\\_GB/document\\_library/EPAR\\_-\\_Public\\_assessment\\_report/human/002430/WC500133771.pdf](http://www.ema.europa.eu/docs/en_GB/document_library/EPAR_-_Public_assessment_report/human/002430/WC500133771.pdf)

Feenstra TL, van Genugten ML, Hoogenveen RT, et al. The impact of aging and smoking on the future burden of chronic obstructive pulmonary disease: a model analysis in the Netherlands. *Am J Respir Crit Care Med* 2001;164:590-596.

Ferrer, Alonso J, Morera J, et al. Chronic obstructive pulmonary disease Part and health related quality of life. *Ann Intern Med*. 1997;127:1072-1079.

Fletcher CM, Elmes PC, Fairbairn MB, et al. The significance of respiratory symptoms and the diagnosis of chronic bronchitis in a working population. *Br Med J*. 1959; 2:257-266.

GOLD (Global Initiative for Chronic Obstructive Lung Disease). Global strategy for the diagnosis, management, and prevention of chronic obstructive pulmonary disease. National Institutes of Health, updated 2015 ([www.goldcopd.com](http://www.goldcopd.com)).

Halbert RJ, Isonaka S, George D, Iqbal A. Interpreting COPD prevalence estimates: what is the true burden of disease? *Chest* 2003;123:1684-1692.



Halbert RJ, Natoli JL, Gano A, et al. Global burden of COPD: systemic review and meta-analysis. *Eur Respir J* 2006;28:523-532.

Miller MR, Crapo R, Hankinson J, et al. ATS/ERS Task Force. General considerations for lung function testing. *Eur Respir J*. 2005; 26:153-61 *Eur Respir J*. 2005; 26:153-61.

Murray CJ, Lopez AD. Alternative projections of mortality and disability by cause 1990-2020: Global Burden of Disease Study. *Lancet* 1997;349:1498-1504.

National Health and Nutrition Examination Survey (NHANES III), 2011. Accessed on 14 July 2014. Available online at: <http://www.cdc.gov/niosh/topics/spirometry/nhanes.html>

New York Heart Association NYHA 2011 NYHA Classification, the Stages of Heart Failure. Accessed on 14 July 2014. Available online at Heart Failure Society of America: [http://www.abouthf.org/questions\\_stages.htm](http://www.abouthf.org/questions_stages.htm)

R Development Core Team, 2003] R Development Core Team (2003). R: A language and environment for statistical computing. R Foundation for Statistical Computing, Vienna, Austria.

Sullivan SD, Ramsey SD, Lee TA. The economic burden of COPD. *Chest* 2000;117:5S-9S.

van Noord JA. Comparison of tiotropium once daily, formoterol twice daily and both combined once daily in subjects with COPD. *European Respiratory Journal*. 2005; 26(2):214–222.

van Noord JA, Aumann JL, Janssens E, Verhaert J, Smeets JJ, Mueller A, Cornelissen PJG. Effects of Tiotropium With and Without Formoterol on Airflow Obstruction and Resting Hyperinflation in Subjects With COPD. *Chest* 2006;129;509-517.

Ventolin (albuterol sulfate) inhalation aerosol HFA. Highlights of Prescribing Information (2012); [REDACTED]

Vogelmeier C, Kardos P, Harari S, Gans SJM, Stenglein S, Thirlwell J. Formoterol mono- and combination therapy with tiotropium in subjects with COPD: A 6-month study. *Respiratory Medicine* (2008) 102, 1511-1520.

Vos W, De Backer J, Poli G, De Volder A, Ghys L, Van Holsbeke C, et al. Novel functional imaging of changes in small airways of subjects treated with extrafine beclomethasone/formoterol. *Respiration*. 2013; 86(5):393–401.

## 12 APPENDICES

### Appendix 1 Subject Instructions for Use of GFF and Placebo MDI

#### Before using GFF MDI and Placebo MDI

1. Take the inhaler out of the foil pouch. Safely throw away the pouch and the drying packet that comes inside the pouch. Check the indicator at the top of the canister; the indicator should read as shown in [Figure A1-1](#).

#### Figure A1-1. Indicator at Top of Canister



2. Take the cap off the inhaler and inspect the front of the inhaler and make sure there is nothing inside the mouthpiece of the inhaler. Make sure the canister is fully and firmly inserted into the actuator.
3. The inhaler should be stored at room temperature.

#### How to prime GFF MDI and Placebo MDI

1. The inhaler must be primed before the first use. Priming involves releasing a certain number of sprays (4) into the air before the first use of the inhaler. Shaking and priming the inhaler fills a chamber inside the canister with the correct dose and mix of medication so that the inhaler is ready to use.
2. Take the cap off the mouthpiece of the actuator.
3. To prime the inhaler, gently shake the inhaler for 5-10 seconds and then spray once into the air away from yourself and others.
4. Wait approximately 5-10 seconds and repeat the process three more times.

#### How to take a dose from GFF MDI and Placebo MDI

Steps 3-6 below should be done one after the other.

1. Take the cap off the mouthpiece of the actuator.
2. Hold the inhaler with the mouthpiece down.
3. Shake the canister for 5-10 seconds.
4. Breathe out fully through mouth, expelling as much air from the lungs as possible.

5. Tilt head back slightly, place the mouthpiece into mouth, and close lips around it. To allow the medication to enter the lungs, keep tongue flat on the floor of your mouth. Keep the mouthpiece at the bottom and the dose indicator at the top.
6. While breathing in deeply and slowly, press down on the center of the dose indicator with finger. Fully depress the canister until it stops moving in the actuator while delivering the dose.  
**Note:** It is normal to hear a soft click from the indicator as it counts down during use.
7. Hold breath as long as possible, up to 10 seconds, and then breathe normally.
8. Repeat steps 3 to 7, with gentle shaking for 5-10 seconds before the second spray.
9. Put the cap back on the mouthpiece after every time the inhaler is used, and make sure it is firmly seated in place.

### How to clean GFF MDI and Placebo MDI

It is very important to keep the plastic actuator clean so the medicine does not build-up and block the spray. The inhaler may stop spraying if it is not cleaned correctly. Do not clean the metal canister or let it get wet.

Wash the actuator once a week for the first three weeks as directed below.

1. Take the canister out of the actuator, and take the cap off the mouthpiece.
2. Wash the actuator through the top of the actuator with warm running water for 30 seconds (see [Figure A1-2](#)).

#### Figure A1-2. Wash Actuator through Top of Actuator

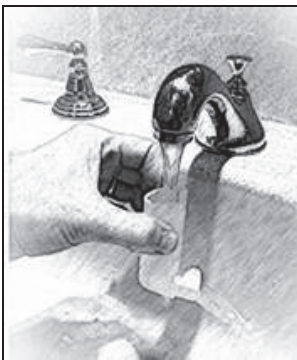

3. Then wash the actuator again through the mouthpiece (see [Figure A1-3](#)).

### Figure A1-3. Wash Actuator through Mouthpiece



4. Shake off as much water from the actuator as you can. Look into the mouthpiece to make sure any medicine build-up has been completely washed away. If there is any visible build-up, repeat steps 2 and 3.
5. Let the actuator air dry completely, such as overnight.
6. When the actuator is dry, put the canister in the actuator, making sure the canister is fully and firmly fitted into the actuator. Shake the inhaler gently for 5-10 seconds and spray it 2 times into the air away from your face, shaking gently 5-10 seconds before each spray. Put the cap back on the mouthpiece.

#### **If the actuator becomes blocked**

Blockage from medicine build-up is more likely to happen if the actuator is not routinely cleaned and the actuator is not air-dried completely. If the actuator gets blocked so that little or no medicine comes out of the mouthpiece, wash the actuator as described in cleaning steps 1-6.

If the inhaler is needed before the actuator is completely dry, shake as much water off the actuator as possible. Put the canister in the actuator and make sure it fits firmly. Shake the inhaler gently for 5-10 seconds and spray it 2 times into the air away from your face, shaking gently 5-10 seconds before each spray. Then take the dose as prescribed and described above. Then clean and air-dry it completely.

#### **How to read the inhaler dose indicator**

The inhaler is fitted with a dose indicator which shows how much medicine is left during use. The dose indicator display will move after every tenth puff. The dose indicator pointer will start to point to the red area when there are 20 puffs remaining. This means that the inhaler needs to be replaced soon.

**Figure A1-4. Metered Dose Inhaler Parts**

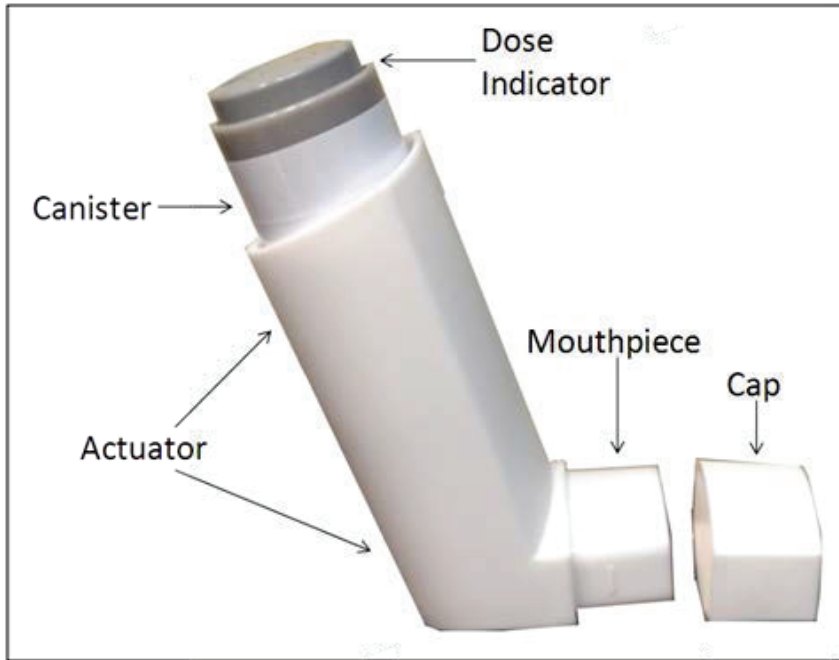

**Figure A1-4. Metered Dose Inhaler Parts**

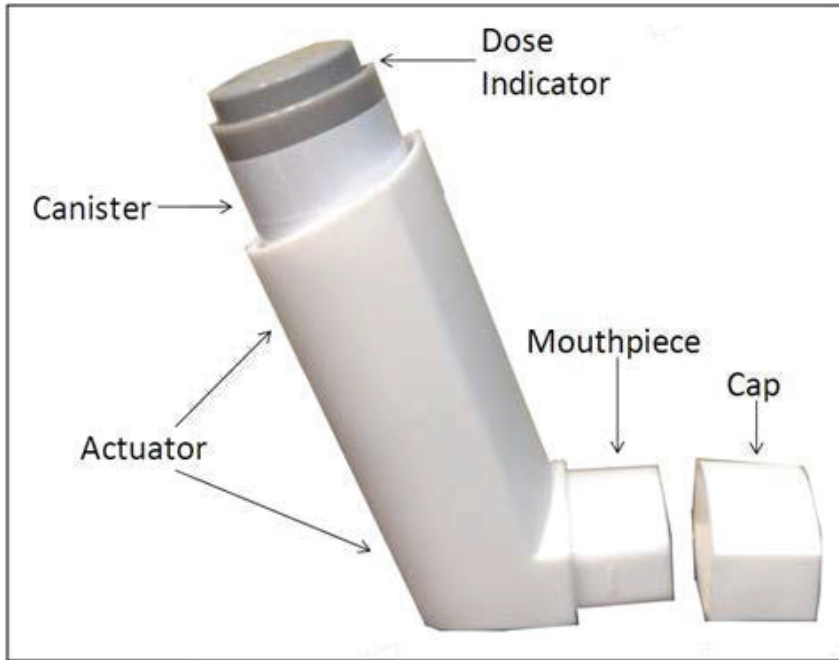

## Appendix 2 Instructions for Use of Atrovent HFA Inhalation Aerosol Device

### Inhaler Description

ATROVENT HFA Inhalation Aerosol (Figure 1) consists of a metal canister containing the medicine and a mouthpiece that releases the medicine from the canister. The mouthpiece includes a clear colorless sleeve, a white plastic portion and a green protective dust cap.

The inhaler comes with a dose indicator you can see through a small window on the plastic mouthpiece (See Figure 1). A new inhaler first shows "200" in the dose indicator window. The dose indicator will show the approximate number of actuations (sprays) of medicine remaining in the inhaler. As you use the inhaler, the dose indicator will typically rotate during every 5 to 7 actuations (sprays) towards the next decreasing number (See Figure 2).

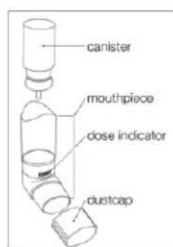

Figure 1

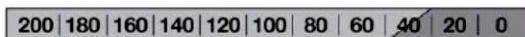

Figure 2



**Instructions for Use:**

1. **Insert the metal canister into the clear end of the mouthpiece (See Figure 1).** Make sure the canister is fully and firmly inserted into the mouthpiece.
  - **The ATROVENT HFA canister is to be used only with the ATROVENT HFA mouthpiece.**
  - **Do not use the ATROVENT HFA mouthpiece with other inhaled medicines.**
2. **Remove the green protective dust cap.** If the cap is not on the mouthpiece, make sure there is nothing in the mouthpiece before use. For best results, the canister should be at room temperature before use.
3. **Breathe out (exhale) deeply through your mouth.** Hold the inhaler upright (See Figure 3), between your thumb and first 2 fingers. Put the mouthpiece in your mouth and close your lips.
  - **Keep your eyes closed so that no medicine will be sprayed into your eyes.** If sprayed into the eyes, ATROVENT HFA can cause blurry vision and other vision abnormalities, eye pain or discomfort, dilated pupils, or narrow-angle glaucoma or worsening of this condition. If any combination of these symptoms develops, you should consult your physician immediately.



Figure 3

4. **Breathe in (inhale) slowly through your mouth and at the same time spray the ATROVENT HFA into your mouth.**
  - To spray ATROVENT HFA firmly press the canister against the mouthpiece 1 time (See Figure 4). Keep breathing in deeply.

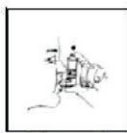

Figure 4

5. **Hold your breath for ten seconds and then take the mouthpiece out of your mouth and breathe out slowly (See Figure 5).**



Figure 5

6. **Wait at least 15 seconds and repeat steps 3 to 5 again.**
7. **Replace the green protective dust cap after use.**
8. **Keep the mouthpiece clean.** At least once a week, wash the mouthpiece, shake it to remove excess water and let it air dry all the way (see **Mouthpiece Cleaning Instructions**).



**Mouthpiece Cleaning Instructions:**

**Step A.** Remove and set aside the canister and dust cap from the mouthpiece (See Figure 1).

**Step B.** Wash the mouthpiece through the top and bottom with warm running water for at least 30 seconds (See Figure 6). Do not use anything other than water to wash the mouthpiece.



Figure 6

**Step C.** Dry the mouthpiece by shaking off the excess water and allow it to air dry all the way.

**Step D.** When the mouthpiece is dry, replace the canister. Make sure the canister is fully and firmly inserted into the mouthpiece.

**Step E.** Replace the green protective dust cap.

If little or no medicine comes out of the mouthpiece, wash the mouthpiece as described in Steps A to E under the "Mouthpiece Cleaning Instructions".

**9. When to get a new ATROVENT HFA inhaler.**

There are approximately 40 actuations (sprays) left when the dose indicator displays "40," where the background changes from green to red (See Figure 7a). This is when you need to refill your prescription or ask your doctor if you need another prescription for ATROVENT HFA inhalation aerosol.

The background color will be all red when the indicator approaches 20. The indicator will stop moving at "0". Discard the inhaler once the dose indicator displays "0" (See Figure 7b). Even though the canister may not be empty, you cannot be sure of the amount of medicine in each actuation (spray) once the dose indicator displays "0".



Figure 7a

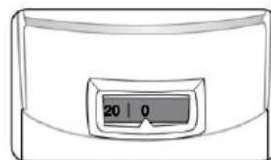

Figure 7b

### Appendix 3 Instructions for Use of Ventolin HFA Inhaler

#### Instructions for Use

#### For Oral Inhalation Only

#### Your VENTOLIN HFA inhaler

- The metal canister holds the medicine. See [Figure A](#).

Figure A

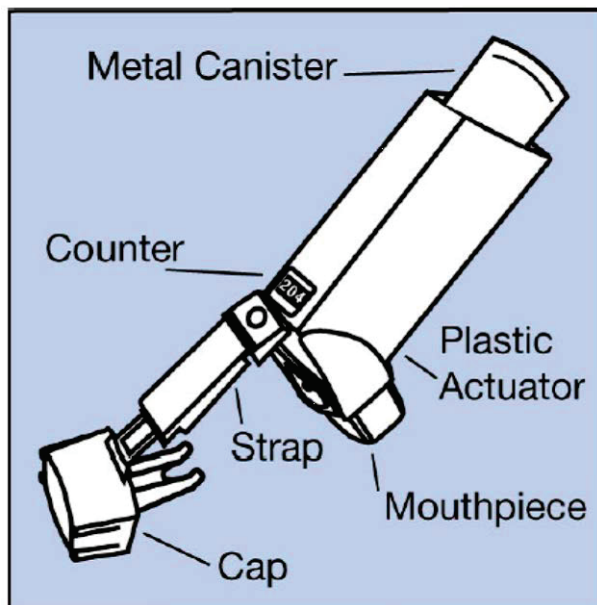
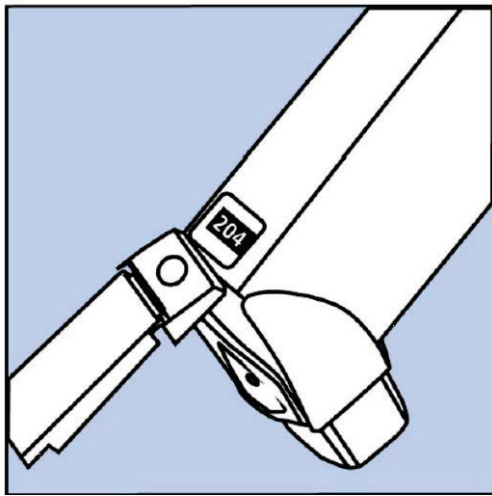

Figure A

The canister has a counter to show how many sprays of medicine you have left. The number shows through a window in the back of the actuator. See [Figure B](#).

**Figure B**



- The counter starts at either **204** or **064**, depending on which size inhaler you have. The number will count down by 1 each time you spray the inhaler. The counter will stop counting at **000**.
- Do not try to change the numbers or take the counter off the metal canister. The counter cannot be reset, and it is permanently attached to the canister.
- The blue plastic actuator sprays the medicine from the canister. The actuator has a protective cap that covers the mouthpiece. See [Figure A](#). Keep the protective cap on the mouthpiece when the canister is not in use. The strap keeps the cap attached to the actuator.
- **Do not** use the actuator with a canister of medicine from any other inhaler.
- **Do not** use a VENTOLIN HFA canister with an actuator from any other inhaler.

### **Before using your VENTOLIN HFA inhaler**

**Before you use VENTOLIN HFA for the first time, you must prime the inhaler so that you will get the right amount of medicine when you use it.**

To prime the inhaler, take the cap off the mouthpiece and shake the inhaler well. Then spray the inhaler 1 time into the air away from your face. See [Figure C](#). **Avoid spraying in eyes.**

**Figure C**

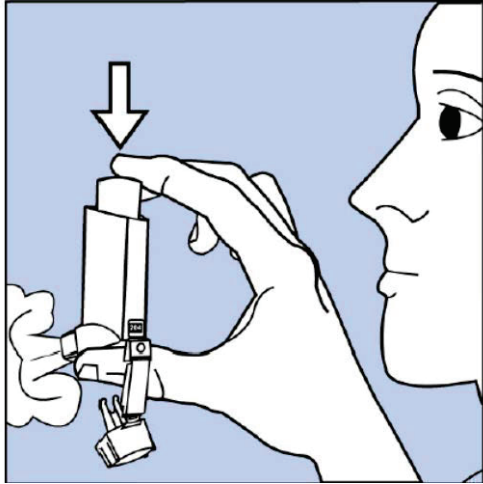

- Shake and spray the inhaler like this 3 more times to finish priming it. The counter should now read **200** or **060**, depending on which size inhaler you have. See [Figure D](#).

**Figure D**

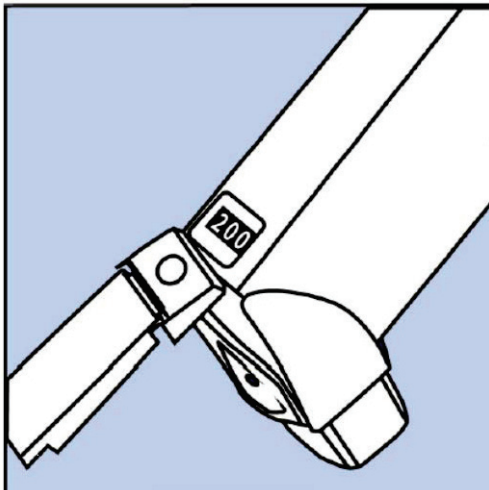

You must prime your inhaler again if you have not used it in more than 14 days or if you drop it. Take the cap off the mouthpiece and shake and spray the inhaler 4 times into the air away from your face.

**How to use your VENTOLIN HFA inhaler**

**Follow these steps every time you use VENTOLIN HFA.**

**Step 1.** Make sure the canister fits firmly in the actuator. The counter should show through the window in the actuator.

**Shake the inhaler well** before each spray.

Take the cap off the mouthpiece of the actuator. Look inside the mouthpiece for foreign objects, and take out any you see.

**Step 2.** Hold the inhaler with the mouthpiece down. See [Figure E](#).

**Figure E**

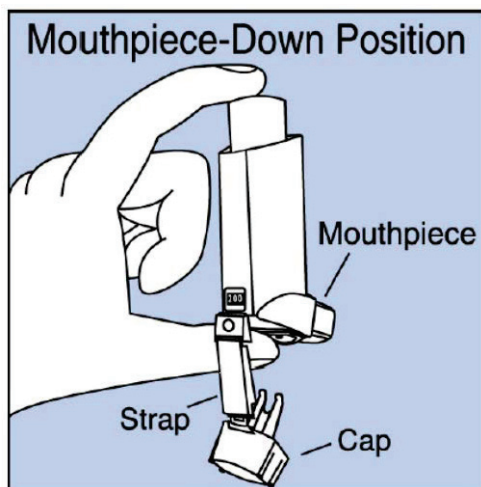

**Step 3.** Breathe out through your mouth and push as much air from your lungs as you can. Put the mouthpiece in your mouth and close your lips around it. See [Figure F](#).

**Figure F**

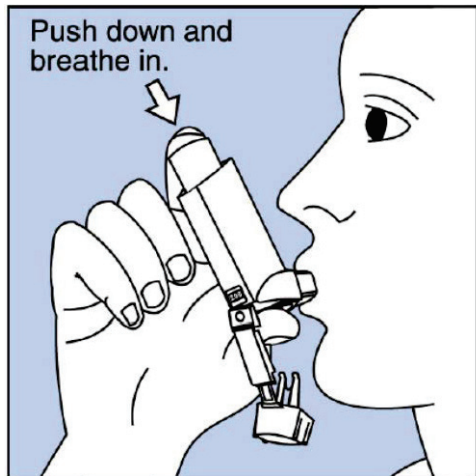

**Step 4.** Push the top of the canister **all the way down** while you breathe in deeply and slowly through your mouth. See [Figure F](#).

**Step 5.** After the spray comes out, take your finger off the canister. After you have breathed in all the way, take the inhaler out of your mouth and close your mouth.

**Step 6.** Hold your breath for about 10 seconds, or for as long as is comfortable. Breathe out slowly as long as you can.

If your healthcare provider has told you to use more sprays, wait 1 minute and shake the inhaler again. Repeat Steps 2 through Step 6.

**Step 7.** Put the cap back on the mouthpiece after every time you use the inhaler. Make sure it snaps firmly into place.

#### **Cleaning your VENTOLIN HFA inhaler**

Clean your inhaler at least 1 time each week. You may not see any medicine build-up on the inhaler, but it is important to keep it clean so medicine build-up will not block the spray. See [Figure G](#).

**Figure G**

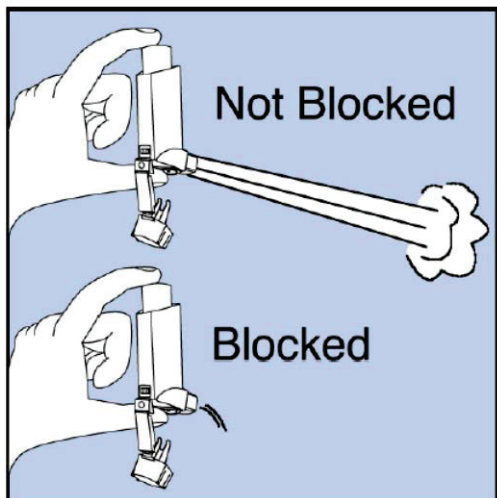

**Step 8.** Take the canister out of the actuator, and take the cap off the mouthpiece. The strap on the cap will stay attached to the actuator.

**Step 9.** Hold the actuator under the faucet and run warm water through it for about 30 seconds. See [Figure H](#).

**Figure H**

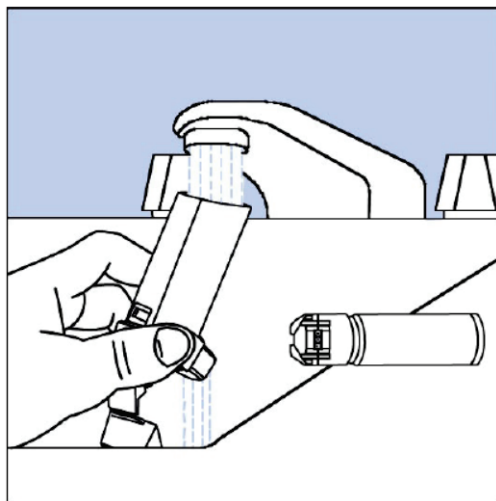

**Step 10.** Turn the actuator upside down and run warm water through the mouthpiece for about 30 seconds. See [Figure I](#).

**Figure I**

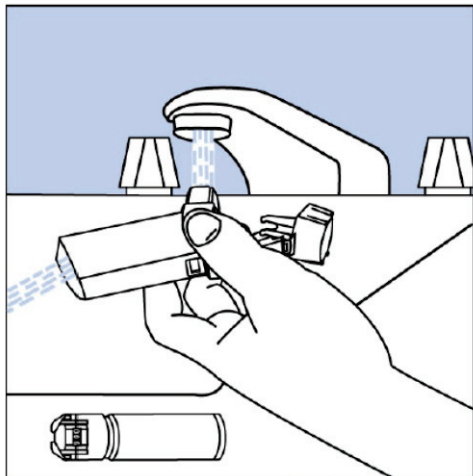

**Step 11.** Shake off as much water from the actuator as you can. Look into the mouthpiece to make sure any medicine build-up has been completely washed away. If there is any build-up, repeat Steps 9 and 10.

**Step 12.** Let the actuator air-dry overnight. See [Figure J](#).

**Figure J**

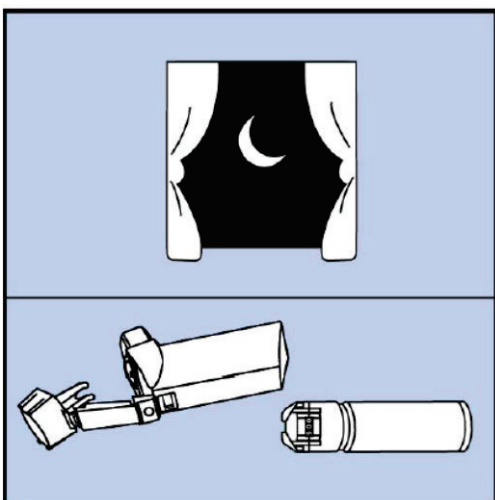

**Step 13.** When the actuator is dry, put the protective cap on the mouthpiece and then put the canister in the actuator and make sure it fits firmly. Shake the inhaler well, remove the cap,



and spray the inhaler once into the air away from your face. (The counter will count down by 1 number.) Put the cap back on the mouthpiece.

**If you need to use your inhaler before the actuator is completely dry:**

- Shake as much water off the actuator as you can.
- Put the cap on the mouthpiece and then put the canister in the actuator and make sure it fits firmly.
- Shake the inhaler well and spray it 1 time into the air away from your face.
- Take your VENTOLIN HFA dose as prescribed.
- Follow cleaning Steps 8 through 13 above.

## Appendix 4 COPD Assessment Test

Underneath an example of the CAT test is visible. During the study CAT test in the local language will be used.

Your name:  Today's date:



### How is your COPD? Take the COPD Assessment Test™ (CAT)

This questionnaire will help you and your healthcare professional measure the impact COPD (Chronic Obstructive Pulmonary Disease) is having on your wellbeing and daily life. Your answers, and test score, can be used by you and your healthcare professional to help improve the management of your COPD and get the greatest benefit from treatment.

For each item below, place a mark (X) in the box that best describes you currently. Be sure to only select one response for each question.

Example: I am very happy (0) **X** (1) (2) (3) (4) (5) I am very sad

			SCORE
I never cough	(0) (1) (2) (3) (4) (5)	I cough all the time	<input type="text"/>
I have no phlegm (mucus) in my chest at all	(0) (1) (2) (3) (4) (5)	My chest is completely full of phlegm (mucus)	<input type="text"/>
My chest does not feel tight at all	(0) (1) (2) (3) (4) (5)	My chest feels very tight	<input type="text"/>
When I walk up a hill or one flight of stairs I am not breathless	(0) (1) (2) (3) (4) (5)	When I walk up a hill or one flight of stairs I am very breathless	<input type="text"/>
I am not limited doing any activities at home	(0) (1) (2) (3) (4) (5)	I am very limited doing activities at home	<input type="text"/>
I am confident leaving my home despite my lung condition	(0) (1) (2) (3) (4) (5)	I am not at all confident leaving my home because of my lung condition	<input type="text"/>
I sleep soundly	(0) (1) (2) (3) (4) (5)	I don't sleep soundly because of my lung condition	<input type="text"/>
I have lots of energy	(0) (1) (2) (3) (4) (5)	I have no energy at all	<input type="text"/>
			<b>TOTAL SCORE</b> <input type="text"/>

COPD Assessment Test and CAT logo is a trademark of the [REDACTED] group of companies. All rights reserved.















## Appendix 5 Modified Medical Research Council Dyspnea Scale Assessment

Underneath an example of the MMRC questionnaire is visible. During the study MMRC in the local language will be used.

Grade	Description of Breathlessness
0	I only get breathless with strenuous exercise.
1	I get short of breath when hurrying on level ground or walking up a slight hill.
2	On level ground, I walk slower than people of the same age because of breathlessness, or have to stop for breath when walking at my own pace.
3	I stop for breath after walking about 100 meters or after a few minutes on level ground.
4	I am too breathless to leave the house or I am breathless when dressing.

## Appendix 6 Dose Indicator Display Reading Instructions

For the purposes of this study, when recording the dose indicator display value, review the indicator display at the top of the MDI and record the number of inhalations remaining that matches the chart below:

130 Count (Actuation) Version Shown				
 <p>If your dose indicator display looks like this record <b>120+</b></p>	 <p>If your dose indicator display looks like this record <b>120</b></p>	 <p>If your dose indicator display looks like this record <b>110</b></p>	 <p>If your dose indicator display looks like this record <b>100</b></p>	 <p>If your dose indicator display looks like this record <b>90</b></p>
 <p>If your dose indicator display looks like this record <b>80</b></p>	 <p>If your dose indicator display looks like this record <b>70</b></p>	 <p>If your dose indicator display looks like this record <b>60</b></p>	 <p>If your dose indicator display looks like this record <b>50</b></p>	 <p>If your dose indicator display looks like this record <b>40</b></p>
 <p>If your dose indicator display looks like this record <b>30</b></p>	 <p>If your dose indicator display looks like this record <b>20</b></p>	 <p>If your dose indicator display looks like this record <b>10</b></p>	 <p>If your dose indicator display looks like this record <b>0</b></p>	

## **Appendix 7 Protocol of HRCT scan and CFD method**

### **10.1 Protocol of CT scan**

For small airways scanning thorax HRCT scans are taken at Visit 2, Visit 3, Visit 4 and Visit 5. The scans on Visit 2 and Visit 4 are taken at two different lung volumes, i.e. TLC and FRC, during breath hold. The scans on Visit 3 and Visit 5 are only taken at TLC level. In order to control the lung volume, the subjects' breathing signal is monitored. During Visit 2 an additional scan of the upper airway will be taken. The scans will be taken with a [REDACTED] 64-slice scanner or a scanner yielding equivalent results.

#### **Monitoring the breathing signal:**

In order to monitor the breathing signal, the subject breaths through a mouthpiece. This mouthpiece is connected with a laptop (via a network cable long enough to bridge the distance between subject in the CT room and the control room) on which specialized software is running. Through a pneumotach in the mouthpiece the flow pattern can be followed. For TLC we ask the subject to breath in fully and to hold his breath for the duration of the scan. When we see the subject is correctly holding his breath, a CT scan is taken. The same procedure is repeated at FRC. We ask the subject to breath in a bit and to slowly blow out until FRC and to hold his breath. At that moment the second CT scan is taken. For the upper airway scan we ask the subject to breath in slowly while the scan is taken.

#### **Scanning protocols:**

For the TLC Scan and FRC scan:

- Rotation time of 0.6 s
- Detector coverage of 40 mm
- Helical thickness of 0.625 mm
- Pitch and speed of 1.375:1 and 55 mm/s.
- Tube voltage: 100 kV
- Tube current: variable between 10 and 200 mAs
- Noise index: 45

The field of view is set as small as possible, but the lung should be seen completely in all axial slices. Scan time lies around 5 seconds. Images are reconstructed at 0.3 mm interval using a lung filter. The resulting data set has 700-1200 images with a pixel size of 0.4-0.65 mm<sup>2</sup>.

#### **UA scan**

- Rotation time of 0.5 s
- Detector coverage of 40 mm
- Helical thickness of 1.250 mm
- Pitch and speed of 0.984:1 and 39.37 mm/s.
- Tube voltage: 100 kV

- Tube current: variable between 10 and 300 mAs
- Noise index: 45

The field of view is set as small as possible, but the upper airway tract should be seen completely in all axial slices. Scan time lies around 2 seconds. Images are reconstructed at 0.625 mm interval using a standard filter. The resulting data set has 250-400 images with a pixel size of 0.5 mm<sup>2</sup>.

The scans taken during all visits shall be obtained with the same radiologic technical conditions. If the scanning equipment can not comply with the above mentioned requirements, settings yielding equivalent results can be applied.

## 10.2 Detailed description of the FRI method

HRCT images are imported into [REDACTED], a commercial, FDA approved, medical image processing software package. [REDACTED]. This software package converts the HRCT images into subject specific, three-dimensional computer models of the lung lobes, the airway lumen and wall, and the vascular tree. These models can be used for (regional) volume calculations and further evaluations of (regional) resistance. The airway and vascular tree are evaluated at FRC and TLC level and can be segmented down to bronchi/vessels with a diameter of around 1-2 mm. Beyond this point the HRCT resolution is insufficient to distinguish alveolar and intraluminal air, or blood vessel tissue and surrounding lung tissues. A typical airway model includes 5-10 generations, depending mainly on the disease state of the individual subject. Airway lumen ( $iV_{aw}$ ), airway wall ( $iV_{aww}$ ) and blood vessel volume ( $V_{bv}$ ) can be assessed at individual airways/vessels or in different regions. By evaluating the lobar volumes at two different levels, lobar expansion and consequently internal mass flow distribution can be determined. Furthermore, the FRC and TLC scan can be used to quantify the (regional) presence of air trapping and emphysema, respectively.

Afterwards the airway lumen models will be smoothed. The smoothed airway models are subsequently trimmed at the trachea and at the terminal bronchi to obtain a model that is suitable for flow calculations. Next, these models are exported to a meshing software package where they are divided into discrete tetrahedral elements. Mesh size for this study will be determined after proper mesh convergence analysis. Based on the resulting computational mesh, flow properties are obtained throughout the entire flow domain by means of Reynolds averaged Navier-Stokes (RANS) CFD. A steady, normal inspiratory flow of 25L/min is simulated for all subjects to mimic the flow properties at tidal breathing. For each individual subject the outflow to each lobe is adjusted iteratively to match the internal flow rate distribution that is obtained from the HRCT scans. From the CFD calculations the resistance ( $iR_{aw}$ ) in individual airways or different regions, corresponding to the volume measurements, are obtained. Resistance is defined as the total pressure drop over an airway divided by the flow rate through that airway.

## Appendix 8 Sponsor Signatory

**Study Title:** A Randomized, Double-Blind, Two Treatment, Two Period, Chronic Dosing (2 Weeks), Cross-Over, Single-Center Study to Evaluate the Effects of PT003 and Placebo MDI on Specific Image Based Airway Volumes and Resistance in Subjects With Moderate to Severe COPD.

**Study Number:** PT003018-02 / FLUI-2015-139

**Final Date:** [REDACTED]

**Signature:** [REDACTED]

**Date:** [REDACTED]

**Name:** [REDACTED]

**Title:** [REDACTED]



## Appendix 9 Investigator's Agreement and Signature Page

**Study Title:** A Randomized, Double-Blind, Two Treatment, Two Period, Chronic Dosing (2 Weeks), Cross-Over, Single-Center Study to Evaluate the Effects of PT003 and Placebo MDI on Specific Image Based Airway Volumes and Resistance in Subjects With Moderate to Severe COPD.

**Study Number:** PT003018-02 / FLUI-2015-139

**Final Date:** [REDACTED]

**I agree:**

- To assume responsibility for the proper conduct of the study at this site.
- To conduct the study in compliance with the protocol and with any other study conduct procedures provided by Pearl Therapeutics, Inc.
- Not to implement any changes to the protocol without agreement from the Sponsor and prior review and written approval from the IRB/IEC, except where necessary to eliminate an immediate hazard to the subjects, or for administrative aspects of the study (where permitted by all applicable regulatory requirements).
- That I am aware of, and will comply with good clinical practices (GCP) and all applicable regulatory requirements.
- That I am thoroughly familiar with the appropriate use of the investigational product(s), and other information provided by the Sponsor including, but not limited to, the following: the protocol and the current Investigator's Brochure (IB).
- To ensure that all persons assisting me with the study are qualified, adequately informed about the investigational product(s) and of their study-related duties and functions.
- To supply Pearl Therapeutic, Inc. with any necessary information regarding ownership interest and financial ties; to promptly update this information if any relevant changes occur during the course of the study and for 1 year following completion of the study; and agree that Pearl Therapeutics, Inc. may disclose any information it has about such ownership interests and financial ties to regulatory authorities.
- I agree to report all information or data in accordance with the protocol and any other study conduct procedures provided by Pearl Therapeutics, Inc.
- That since the information in this protocol and IB is confidential, I understand that its disclosure to any third parties, other than those involved in approval, supervision or conduct of the study is prohibited.
- To accurately transfer all required data from each subject's source document to the case report forms (CRFs). The CRFs will be provided to the Sponsor in a timely manner at the completion of the study, or as otherwise specified by the Sponsor.
- To allow authorized representatives of Pearl Therapeutics, Inc. or regulatory authority representatives to conduct on-site visits to review, audit and copy study documents. I will personally meet with these representatives to answer any study-related questions.

Signature: \_\_\_\_\_

Date: \_\_\_\_\_

Name: \_\_\_\_\_

Affiliation: \_\_\_\_\_



## Appendix 2 Instructions for Use of Atrovent HFA Inhalation Aerosol Device

### Inhaler Description

ATROVENT HFA Inhalation Aerosol (Figure 1) consists of a metal canister containing the medicine and a mouthpiece that releases the medicine from the canister. The mouthpiece includes a clear colorless sleeve, a white plastic portion and a green protective dust cap.

The inhaler comes with a dose indicator you can see through a small window on the plastic mouthpiece (See Figure 1). A new inhaler first shows "200" in the dose indicator window. The dose indicator will show the approximate number of actuations (sprays) of medicine remaining in the inhaler. As you use the inhaler, the dose indicator will typically rotate during every 5 to 7 actuations (sprays) towards the next decreasing number (See Figure 2).

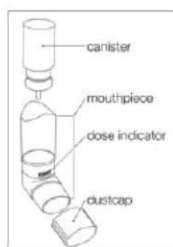

Figure 1



Figure 2

**Instructions for Use:**

1. **Insert the metal canister into the clear end of the mouthpiece (See Figure 1).** Make sure the canister is fully and firmly inserted into the mouthpiece.
  - **The ATROVENT HFA canister is to be used only with the ATROVENT HFA mouthpiece.**
  - **Do not use the ATROVENT HFA mouthpiece with other inhaled medicines.**
2. **Remove the green protective dust cap.** If the cap is not on the mouthpiece, make sure there is nothing in the mouthpiece before use. For best results, the canister should be at room temperature before use.
3. **Breathe out (exhale) deeply through your mouth.** Hold the inhaler upright (See Figure 3), between your thumb and first 2 fingers. Put the mouthpiece in your mouth and close your lips.
  - **Keep your eyes closed so that no medicine will be sprayed into your eyes.** If sprayed into the eyes, ATROVENT HFA can cause blurry vision and other vision abnormalities, eye pain or discomfort, dilated pupils, or narrow-angle glaucoma or worsening of this condition. If any combination of these symptoms develops, you should consult your physician immediately.

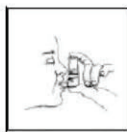

Figure 3

4. **Breathe in (inhale) slowly through your mouth and at the same time spray the ATROVENT HFA into your mouth.**
  - **To spray ATROVENT HFA firmly press the canister against the mouthpiece 1 time (See Figure 4).** Keep breathing in deeply.

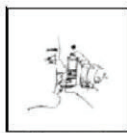

Figure 4

5. **Hold your breath for ten seconds and then take the mouthpiece out of your mouth and breathe out slowly (See Figure 5).**



Figure 5

6. **Wait at least 15 seconds and repeat steps 3 to 5 again.**
7. **Replace the green protective dust cap after use.**
8. **Keep the mouthpiece clean.** At least once a week, wash the mouthpiece, shake it to remove excess water and let it air dry all the way (see **Mouthpiece Cleaning Instructions**).

**Mouthpiece Cleaning Instructions:**

**Step A.** Remove and set aside the canister and dust cap from the mouthpiece (See Figure 1).

**Step B.** Wash the mouthpiece through the top and bottom with warm running water for at least 30 seconds (See Figure 6). Do not use anything other than water to wash the mouthpiece.



Figure 6

**Step C.** Dry the mouthpiece by shaking off the excess water and allow it to air dry all the way.

**Step D.** When the mouthpiece is dry, replace the canister. Make sure the canister is fully and firmly inserted into the mouthpiece.

**Step E.** Replace the green protective dust cap.

If little or no medicine comes out of the mouthpiece, wash the mouthpiece as described in Steps A to E under the "Mouthpiece Cleaning Instructions".

**9. When to get a new ATROVENT HFA inhaler.**

There are approximately 40 actuations (sprays) left when the dose indicator displays "40," where the background changes from green to red (See Figure 7a). This is when you need to refill your prescription or ask your doctor if you need another prescription for ATROVENT HFA inhalation aerosol.

The background color will be all red when the indicator approaches 20. The indicator will stop moving at "0". Discard the inhaler once the dose indicator displays "0" (See Figure 7b). Even though the canister may not be empty, you cannot be sure of the amount of medicine in each actuation (spray) once the dose indicator displays "0".



Figure 7a

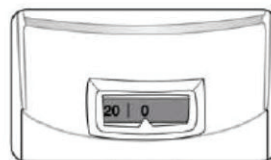

Figure 7b

### Appendix 3 Instructions for Use of Ventolin HFA Inhaler

#### Instructions for Use

#### For Oral Inhalation Only

#### Your VENTOLIN HFA inhaler

- The metal canister holds the medicine. See [Figure A](#).

Figure A

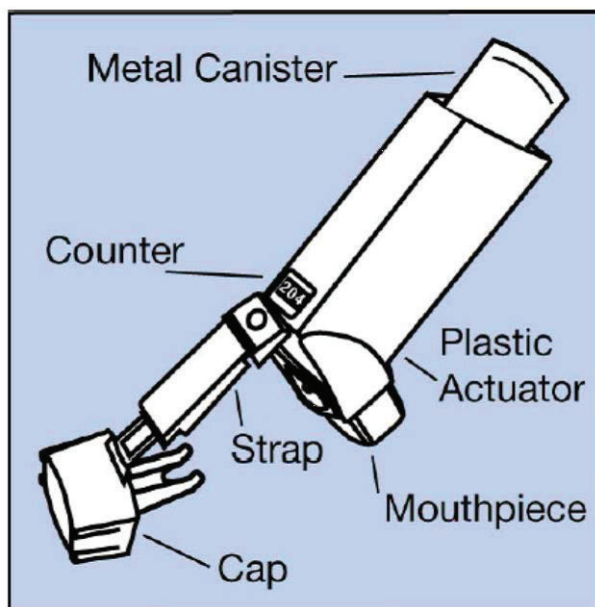
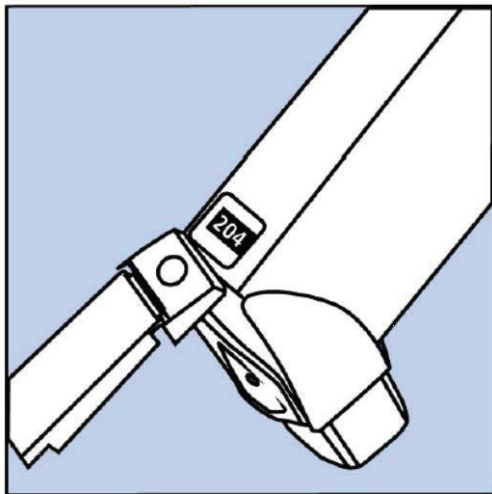

Figure A

The canister has a counter to show how many sprays of medicine you have left. The number shows through a window in the back of the actuator. See [Figure B](#).

**Figure B**



- The counter starts at either **204 or 064**, depending on which size inhaler you have. The number will count down by 1 each time you spray the inhaler. The counter will stop counting at **000**.
- Do not try to change the numbers or take the counter off the metal canister. The counter cannot be reset, and it is permanently attached to the canister.
- The blue plastic actuator sprays the medicine from the canister. The actuator has a protective cap that covers the mouthpiece. See [Figure A](#). Keep the protective cap on the mouthpiece when the canister is not in use. The strap keeps the cap attached to the actuator.
- **Do not** use the actuator with a canister of medicine from any other inhaler.
- **Do not** use a VENTOLIN HFA canister with an actuator from any other inhaler.

### **Before using your VENTOLIN HFA inhaler**

**Before you use VENTOLIN HFA for the first time, you must prime the inhaler so that you will get the right amount of medicine when you use it.**

To prime the inhaler, take the cap off the mouthpiece and shake the inhaler well. Then spray the inhaler 1 time into the air away from your face. See [Figure C](#). **Avoid spraying in eyes.**

**Figure C**

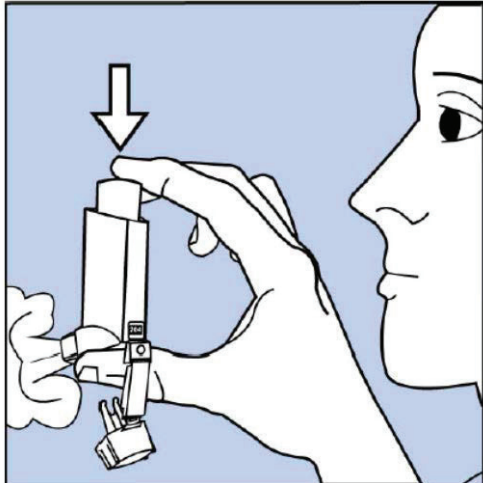

- Shake and spray the inhaler like this 3 more times to finish priming it. The counter should now read **200** or **060**, depending on which size inhaler you have. See [Figure D](#).

**Figure D**

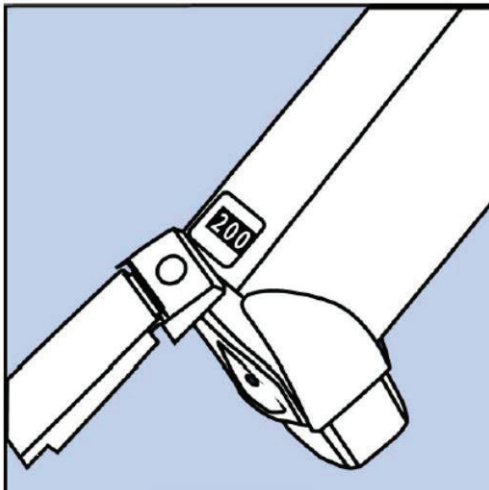

You must prime your inhaler again if you have not used it in more than 14 days or if you drop it. Take the cap off the mouthpiece and shake and spray the inhaler 4 times into the air away from your face.

**How to use your VENTOLIN HFA inhaler**

**Follow these steps every time you use VENTOLIN HFA.**

**Step 1.** Make sure the canister fits firmly in the actuator. The counter should show through the window in the actuator.

**Shake the inhaler well** before each spray.

Take the cap off the mouthpiece of the actuator. Look inside the mouthpiece for foreign objects, and take out any you see.

**Step 2.** Hold the inhaler with the mouthpiece down. See [Figure E](#).

**Figure E**

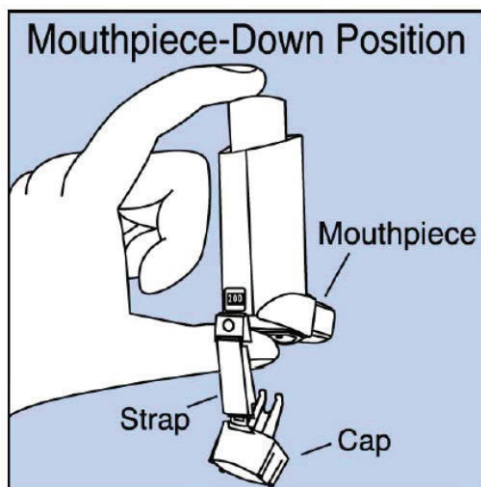

**Step 3.** Breathe out through your mouth and push as much air from your lungs as you can. Put the mouthpiece in your mouth and close your lips around it. See [Figure F](#).



**Figure F**

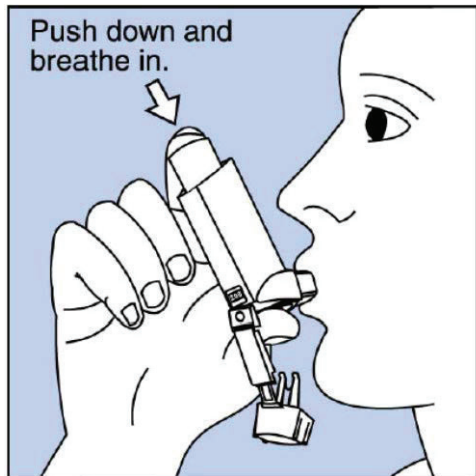

**Step 4.** Push the top of the canister **all the way down** while you breathe in deeply and slowly through your mouth. See [Figure F](#).

**Step 5.** After the spray comes out, take your finger off the canister. After you have breathed in all the way, take the inhaler out of your mouth and close your mouth.

**Step 6.** Hold your breath for about 10 seconds, or for as long as is comfortable. Breathe out slowly as long as you can.

**If your healthcare provider has told you to use more sprays,** wait 1 minute and shake the inhaler again. Repeat Steps 2 through Step 6.

**Step 7.** Put the cap back on the mouthpiece after every time you use the inhaler. Make sure it snaps firmly into place.

#### **Cleaning your VENTOLIN HFA inhaler**

Clean your inhaler at least 1 time each week. You may not see any medicine build-up on the inhaler, but it is important to keep it clean so medicine build-up will not block the spray. See [Figure G](#).



**Figure G**

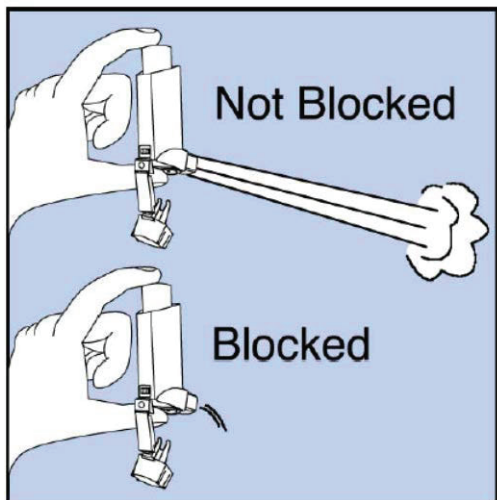

**Step 8.** Take the canister out of the actuator, and take the cap off the mouthpiece. The strap on the cap will stay attached to the actuator.

**Step 9.** Hold the actuator under the faucet and run warm water through it for about 30 seconds. See [Figure H](#).

**Figure H**

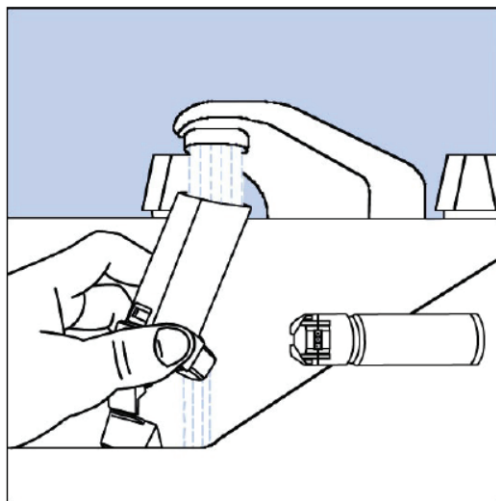

**Step 10.** Turn the actuator upside down and run warm water through the mouthpiece for about 30 seconds. See [Figure I](#).

**Figure I**

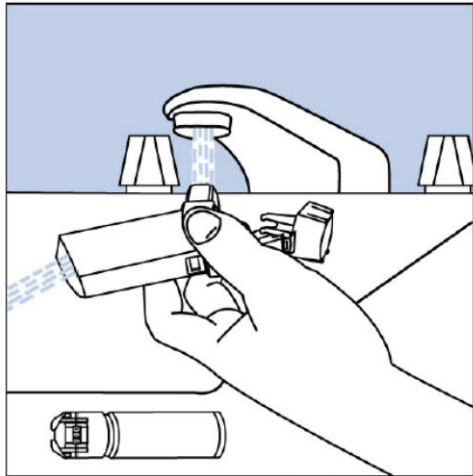

**Step 11.** Shake off as much water from the actuator as you can. Look into the mouthpiece to make sure any medicine build-up has been completely washed away. If there is any build-up, repeat Steps 9 and 10.

**Step 12.** Let the actuator air-dry overnight. See [Figure J](#).

**Figure J**

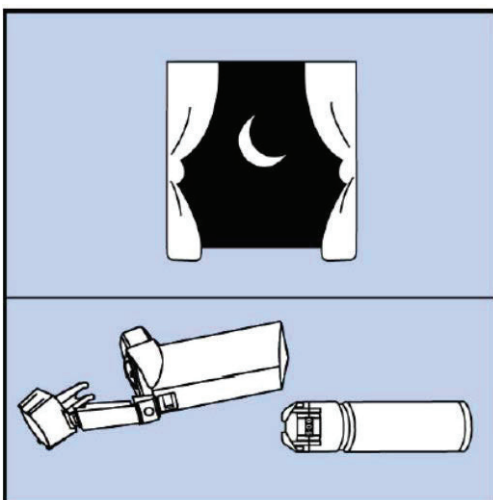

**Step 13.** When the actuator is dry, put the protective cap on the mouthpiece and then put the canister in the actuator and make sure it fits firmly. Shake the inhaler well, remove the cap,

## Appendix 4 COPD Assessment Test

Underneath an example of the CAT test is visible. During the study CAT test in the local language will be used.

Your name:  Today's date:



### How is your COPD? Take the COPD Assessment Test™ (CAT)

This questionnaire will help you and your healthcare professional measure the impact COPD (Chronic Obstructive Pulmonary Disease) is having on your wellbeing and daily life. Your answers, and test score, can be used by you and your healthcare professional to help improve the management of your COPD and get the greatest benefit from treatment.

For each item below, place a mark (X) in the box that best describes you currently. Be sure to only select one response for each question.

Example: I am very happy (0)  (1) (2) (3) (4) (5) I am very sad

			SCORE
I never cough	(0) (1) (2) (3) (4) (5)	I cough all the time	<input type="text"/>
I have no phlegm (mucus) in my chest at all	(0) (1) (2) (3) (4) (5)	My chest is completely full of phlegm (mucus)	<input type="text"/>
My chest does not feel tight at all	(0) (1) (2) (3) (4) (5)	My chest feels very tight	<input type="text"/>
When I walk up a hill or one flight of stairs I am not breathless	(0) (1) (2) (3) (4) (5)	When I walk up a hill or one flight of stairs I am very breathless	<input type="text"/>
I am not limited doing any activities at home	(0) (1) (2) (3) (4) (5)	I am very limited doing activities at home	<input type="text"/>
I am confident leaving my home despite my lung condition	(0) (1) (2) (3) (4) (5)	I am not at all confident leaving my home because of my lung condition	<input type="text"/>
I sleep soundly	(0) (1) (2) (3) (4) (5)	I don't sleep soundly because of my lung condition	<input type="text"/>
I have lots of energy	(0) (1) (2) (3) (4) (5)	I have no energy at all	<input type="text"/>
			<b>TOTAL SCORE</b> <input type="text"/>

COPD Assessment Test and CAT logo is a trademark of the [REDACTED] group of companies. All rights reserved.